



Basic 1D and 2D Experiments

Introduction to 1- and 2-
dimensional NMR Spectroscopy

Version 001



The information in this manual may be altered without notice.

BRUKER BIOSPIN accepts no responsibility for actions taken as a result of use of this manual. BRUKER BIOSPIN accepts no liability for any mistakes contained in the manual, leading to coincidental damage, whether during installation or operation of the instrument. Unauthorized reproduction of manual contents, without written permission from the publishers, or translation into another language, either in full or in part, is forbidden.

This manual was written and desktop published by

Sandra Loss (Application)

Till Kühn (Application)

© September 2, 2005: Bruker Biospin AG

Fällanden, Switzerland

P/N: xxxxx

DWG-Nr.: 1232001

1	Introduction	7
1.1	Goals of this course	7
1.2	The NMR Spectrometer	8
1.3	Bruker NMR software	8
1.3.1	The basic TopSpin window	8
1.3.2	Predefined Parameter Sets	10
1.3.3	TopSpin parameters and commands	12
1.4	Sample Preparation	15
1.5	Tuning and Matching	16
1.5.1	Tuning and Matching on ATM Probes	17
1.5.2	Tuning and Matching ^1H (non ATM Probes)	18
1.5.3	Tuning and Matching ^{13}C (non ATM Probes)	20
1.6	Locking	21
1.6.1	Autolock	21
1.6.2	Adjustment of field and lock phase and power	21
1.6.3	Optimize lock settings (optional)	24
1.7	Shimming	25
1.7.1	Manual Shimming	25
1.7.2	Gradient Shimming	26
2	The 1D Proton Experiment	27
2.1	General information about the experiment	27
2.1.1	Pulse sequence and a few NMR details	27
2.2	Preparation and Acquisition	28
2.2.1	Data acquisition step by step	28
2.2.2	Important acquisition parameters for this experiment	29
2.3	Spectral processing	30
2.3.1	Automatic processing	30
2.3.2	Manual processing	30
2.3.3	Processing parameters	33
2.4	Post-processing	34
2.4.1	Peak picking	34
2.4.2	Integration	35
2.5	Spectra interpretation	37
2.6	Possible pitfalls	40
3	Basic ^{13}C Experiments	44
3.1	General information about the experiments	44
3.1.1	Pulse sequences and a few NMR details	44
3.2	Preparation and Acquisition	47
3.2.1	Data acquisition step by step	47
3.2.2	Important acquisition parameters for this experiment	48
3.3	Spectral processing	49
3.3.1	Automatic processing	49
3.3.2	Manual processing	49
3.3.3	Processing parameters	52
3.4	Post-processing	52
3.4.1	Peak picking	53
3.4.2	Integration	54

3.5	Spectra interpretation	56
3.6	Possible pitfalls	58
4	<i>¹³C Experiments to Assess Multiplicities: DEPT and APT</i>	60
4.1	General information about the experiments	60
4.1.1	Pulse sequences and a few NMR details	60
4.2	Preparation and Acquisition	62
4.2.1	Data acquisition step by step	62
4.2.2	Important acquisition parameters for these experiments	64
4.3	Spectral processing	65
4.3.1	Automatic processing	65
4.3.2	Manual processing	65
4.3.3	Processing parameters	68
4.4	Post-processing	69
4.4.1	Peak picking	69
4.5	Spectra interpretation	70
4.6	Possible pitfalls	71
5	<i>The COSY Experiment</i>	73
5.1	General information about the experiment	73
5.1.1	Pulse sequence and a few NMR details	73
5.2	Preparation and Acquisition	75
5.2.1	Data acquisition step by step	75
5.2.2	Important acquisition parameters for this experiment	76
5.3	Spectral processing	80
5.3.1	Automatic processing	80
5.3.2	Manual processing	80
5.3.3	Processing parameters	82
5.3.4	Processing parameters	86
5.4	Post-processing	88
5.4.1	Peak picking	88
5.4.2	Projections	89
5.5	Spectra interpretation	90
5.6	Possible pitfalls	92
6	<i>The TOCSY Experiment</i>	96
6.1	General information about the experiment	96
6.1.1	Pulse sequence and a few NMR details	96
6.2	Preparation and Acquisition	97
6.2.1	Data acquisition step by step	97
6.2.2	Important acquisition parameters for this experiment	98
6.3	Spectral processing	100
6.3.1	Automatic processing	100
6.3.2	Manual processing	101
6.3.3	Processing parameters	103
6.4	Post-processing	105
6.4.1	Peak picking	105
6.4.2	Projections	106
6.5	Spectra interpretation	107
6.6	Possible pitfalls	108

7	<i>The NOESY Experiment</i>	111
7.1	General information about the experiment	111
7.1.1	Pulse sequence and a few NMR details	111
7.2	Preparation and Acquisition	112
7.2.1	Data acquisition step by step	112
7.2.2	Important acquisition parameters for this experiment	113
7.2.3	Optimization of the mixing time	116
7.3	Spectral processing	117
7.3.1	Automatic processing	117
7.3.2	Manual processing	117
7.3.3	Processing parameters	120
7.4	Post-processing	122
7.4.1	Peak picking	122
7.4.2	Projections	123
7.5	Spectra interpretation	124
7.6	Possible pitfalls	125
8	<i>The ROESY Experiment</i>	127
8.1	General information about the experiment	127
8.1.1	Pulse sequence and a few NMR details	127
8.2	Preparation and Acquisition	128
8.2.1	Data acquisition step by step	128
8.2.2	Important acquisition parameters for this experiment	129
8.2.3	Optimization of the mixing time	131
8.3	Spectral processing	133
8.3.1	Automatic processing	133
8.3.2	Manual processing	133
8.3.3	Processing parameters	136
8.4	Post-processing	138
8.4.1	Peak picking	138
8.4.2	Projections	139
8.5	Spectra interpretation	139
8.6	Possible pitfalls	141
9	<i>The HMQC Experiment</i>	142
9.1	General information about the experiment	142
9.1.1	Pulse sequence and a few NMR details	142
9.2	Preparation and Acquisition	143
9.2.1	Data acquisition step by step	144
9.2.2	Important acquisition parameters for this experiment	145
9.3	Spectral processing	148
9.3.1	Automatic processing	148
9.3.2	Manual processing	149
9.3.3	Processing parameters	151
9.4	Post-processing	153
9.4.1	Peak picking	153
9.4.2	Projections	154
9.5	Spectra interpretation	154
9.6	Possible pitfalls	155
10	<i>The HMBC Experiment</i>	157

10.1	General information about the experiment	157
10.1.1	Pulse sequence and a few NMR details	157
10.2	Preparation and Acquisition	158
10.2.1	Data acquisition step by step	158
10.2.2	Important acquisition parameters for this experiment	159
10.3	Spectral processing	162
10.3.1	Automatic processing	162
10.3.2	Manual processing	163
10.3.3	Processing parameters	164
10.4	Post-processing	166
10.4.1	Peak picking	166
10.4.2	Projections	167
10.5	Spectra interpretation	167
10.6	Possible pitfalls	167
11	<i>The HSQC Experiment</i>	169
11.1	General information about the experiment	169
11.1.1	Pulse sequence and a few NMR details	169
11.2	Preparation and Acquisition	170
11.2.1	Data acquisition step by step	170
11.2.2	Important acquisition parameters for this experiment	172
11.3	Spectral processing	175
11.3.1	Automatic processing	176
11.3.2	Manual processing	176
11.3.3	Processing parameters	178
11.4	Post-processing	180
11.4.1	Peak picking	180
11.4.2	Projections	181
11.5	Spectra interpretation	182
11.6	Possible pitfalls	182
12	<i>Plotting</i>	184
12.1	Starting the program	184
12.2	Plotting a 1D spectrum	185
12.2.1	Basic editing of a 1D spectrum	185
12.2.2	Inserting an expansion	187
12.3	Plotting of a 2D spectrum	187
12.3.1	Basic editing of a 2D spectrum	188

1 Introduction

1.1 Goals of this course

The goal of the present course is to give you an introduction into the basic one- and two dimensional experiments that are commonly used to solve structural problems.

We will start with an overview over sample preparation and the basic spectrometer setup and handling. On the experimental side we will cover proton and heteronuclear 1D experiments, as well as homonuclear and inverse 2D experiments. The description of the experiments covers the basic principle, the information content and interpretation of the spectra, as well as the setup of the acquisition and processing parameters. An individual chapter covers the plotting of 1D and 2D spectra.

This manual refers to the use of the TopSpin software. Compared to the former software XWIN-NMR it offers many intuitive buttons and interactive possibilities which are described throughout this manual. However, for all of these tasks there is also a command existing that can be typed onto the command line or can be chosen from the menu and will then have exactly the same effect. For not confusing customers, who still work with XWIN-NMR these commands are still given.

We hope that we will have convinced you by the end of the course, that NMR is not a mysterious world that can only be understood by some specialised scientists, but a very powerful tool that can easily help you in structural questions.

The application team of Bruker Switzerland.

1.2 The NMR Spectrometer

The NMR spectrometer consists of three major components: (1) The superconducting magnet with the probe, which contains the sample to be measured; (2) The console, which contains all the electronics used for transmission and reception of radio frequency (rf) pulses through the pre-amplifier to the probe; (3) The computer, from where the operator runs the experiments and processes the acquired NMR data.

1.3 Bruker NMR software

There are three major tasks that are controlled by the NMR software: acquisition, processing and plotting. The TopSpin program is the user interface for all of these tasks. Compared to the former XWIN-NMR software, TopSpin is much more intuitive for people who had been working with other windows programs before. However, all the basic commands you were used to from XWIN-NMR will still work on TopSpin!

1.3.1 The basic TopSpin window

The basic TopSpin window is displayed in Figure 1.1

Like before, the commands can be called up by selecting the items from the menu bar (1, Figure 1.1) or by typing the appropriate command in the command line (2, Figure 1.1). Additionally there is an icon bar (3, Figure 1.1) that contains some buttons which will execute some more often used commands. This bar can be customized by the user, i.e. buttons can be added or deleted with respect to your own needs!

The main window always contains the active screen. This possesses an extra menu bar (4, Figure 1.1) where you can choose, what you actually would like to be displayed in the main window. If you are setting up an experiment, you will have access to the acquisition and processing parameters, to the FID, the spectrum, title, pulse program and so on. Whenever you click on one of these tasks, the respective parameters or figures will be displayed and can eventually be altered.

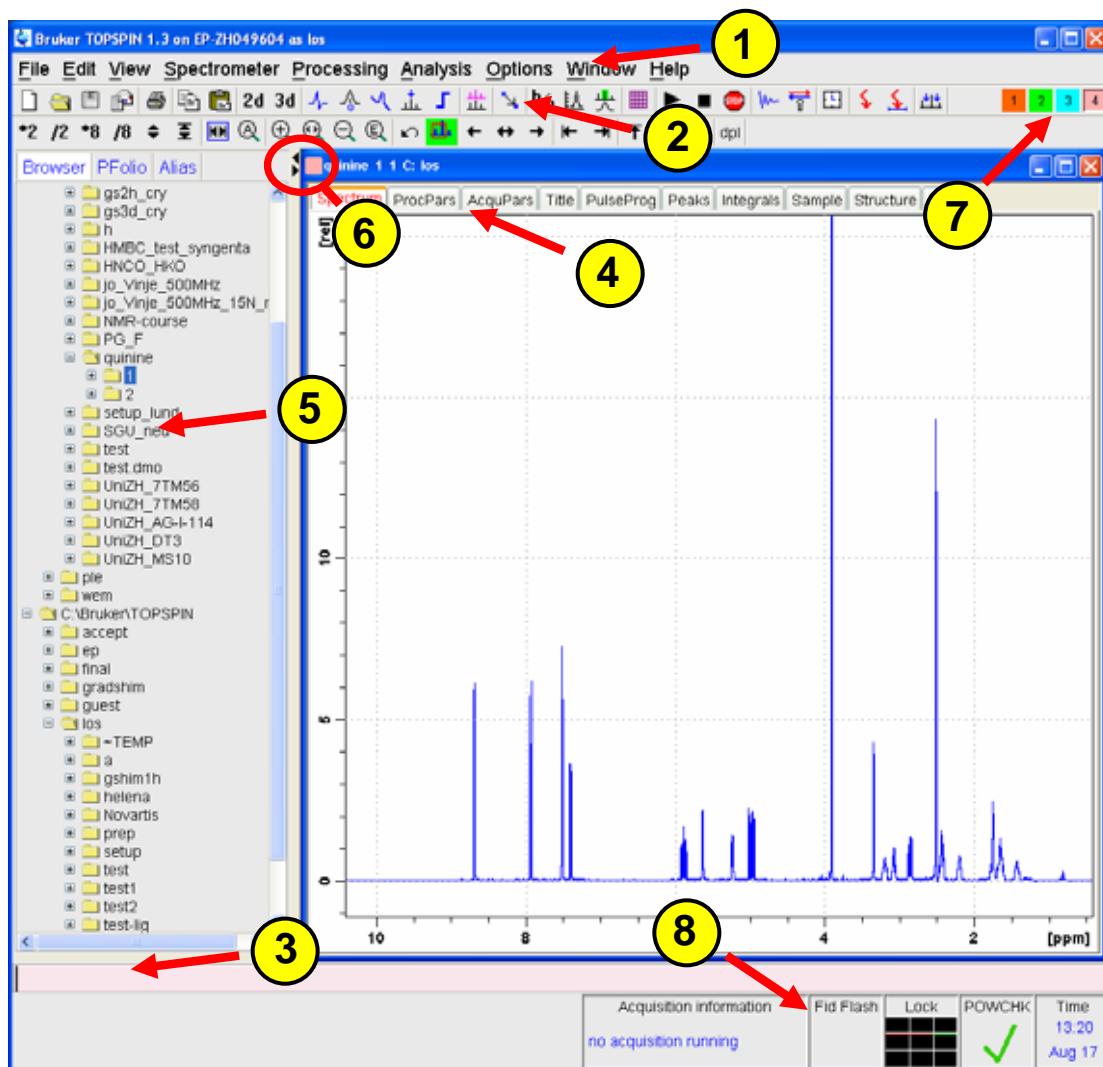
These parameters and the measured data as well as the processed spectra are stored in specific datasets. The file tree has the following general structure:

```
Bruker/TopSpin/data/user_name/nmr/exp_name/exp_no/pdata/proc_no
```

Under this path, the files can be found on your computer. In TopSpin you can get a reduced file tree (the parts of the tree that are always kept the same are omitted) projected in your window (5, Figure 1.1) if you click on the arrow cursor on the left edge (6, Figure 1.1) to open up a side window and chose the Browser from the tags. If the directory where the data is stored is not directly displayed it can be included with a right mouse click on the window. Choose the option "Add New Data Dir ..." and type in the path, where your NMR data can be found. After clicking "OK" the directory will be

added to the file tree. To open an existing data set simply click on the desired experiment file with the left mouse button and drag it into the main display window.

Figure 1.1: The TopSpin window



Note, that it is now possible to have several spectral windows open at the same time! Every open window is represented by a small colored and numbered square (7, Figure 1.1). Clicking on one of these will bring you back to the according window.

By clicking on the grey field below the command line with the right mouse button, the acquisition status bar (8, Figure 1.1) can be switched on and off. This bar yields some information about the actual status of the system: whether it is pulsing or not, how many scans and/or increments had been running already, the actual lock level, and so on.

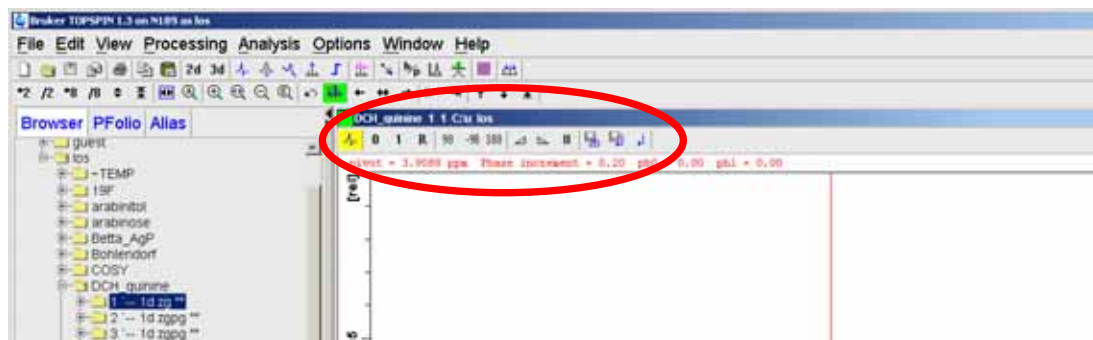
To alter the display properties of the basic TopSpin window, type **setres** on the command line. A dialog box will open that allows you to choose colors, start up options, layout, etc.

If more or less information is needed on the spectral display window, right click with the mouse inside that window. A small dialog box will open that

allows you to choose, whether the cursor information, peak labels, title, integrals, etc. should be displayed in this window.

Whenever any icon is clicked or a command is given that needs some interactive input from the user (for example manual phase correction, baseline correction or integration) the main display window will switch to a display that is appropriate for the desired task. While the spectrum is still displayed, the menu tags on top are replaced by some icons that allow an easy access to all important parameters for the task (see Figure 1.2).

Figure 1.2: Icon bar in the phase correction mode.



1.3.2 Predefined Parameter Sets

To record spectra, a lot of parameters need to be adjusted in order to get reliable results. To make this task a little easier the basic philosophy is to work with predefined parameter sets that are already included in the software and exist for a whole range of different spectroscopic experiments. These parameter sets include the pulse program, acquisition and processing AU programs as well as all other necessary parameters except spectrometer specific values for pulse lengths and power levels. With a few exceptions, the standard parameter sets have the same base name as the corresponding pulse program. Each parameter set can be read into a dataset of your choice by the command **rpar**. You can modify the parameters and save the new parameter set by the command **wpar**. Bruker predefined parameter sets are written in capital letters, and we recommend that you do not change them but rather create new ones that you can use just as well.

The following list is a short summary of the most commonly used experiments and the corresponding parameter sets. The emphasis is on the spectroscopic information that you will get from the experiments rather than on the type of experiment. (For the experiments in this table, it is always recommended to use the gradient version of the experiment if you have the required z-gradient hardware. These experiments usually require less time than the ones without gradients).

Table 1.1: Short List of Typical Experiments, Parameter Sets and What They Do

Atom / Group	Information (1D Experiments)	a.k.a.	Parameter Set
H	¹ H chemical shift and coupling	1D ¹ H	PROTON
C	¹³ C chemical shift, ¹ H decoupled (signal enhancement, integration not possible)	1D ¹³ C	C13CPD
C	¹³ C chemical shift, ¹ H coupled (signal enhancement, integration not possible)	1D ¹³ C	C13GD
C	¹³ C chemical shift, ¹ H decoupled (no signal enhancement, integration possible)	1D ¹³ C	C13IG
CH, CH ₂ , CH ₃	¹³ C chemical shift, select CH, CH ₂ and CH ₃ signals only (same phase)	DEPT45	C13DEPT45
CH	¹³ C chemical shift, select CH signals only	DEPT90	C13DEPT90
CH, CH ₂ , CH ₃	¹³ C chemical shift, select CH, CH ₃ and CH ₂ signals only (opposite phase)	DEPT135	C13DEPT135
C	¹³ C chemical shift, C and CH ₂ have the opposite phase from CH and CH ₃	APT	C13APT

Correlation	Information (2D Experiments)	a.k.a.	Parameter Set
H-H	¹ H/ ¹ H nearest neighbor, through bond chemical shift correlation	COSY	COSYGPSW ¹ COSY45SW
H-H	¹ H/ ¹ H nearest neighbor, through bond chemical shift correlation plus coupling constants	DQF-COSY	COSYGPDPHPSW ¹ COSYDQFPHSW
H-(⁻) _n H	¹ H/ ¹ H total spin system through bond chemical shift correlation	TOCSY	MLEVPHSW
C-H	Sensitive ¹ H/ ¹³ C directly bound chemical shift correlation (one bond), lower resolution in ¹³ C dimension	HSQC CHMQC	HSQCGP ¹ HMQCPH
C-H	Sensitive ¹ H/ ¹³ C directly bound chemical shift correlation (one bond), lower resolution in ¹³ C dimension (small molecules, solemnly select ¹³ C/ ¹ H not ¹² C/ ¹ H)	BIRD-CHMQC	HMQCBIPH
C-(⁻) _n H	Sensitive ¹ H/ ¹³ C long range chemical shift correlation (more than one bond), lower resolution in ¹³ C dimension	HMBC	HMBCLPND
H ^{···} H	¹ H/ ¹ H non bound structural neighbor, through space chemical shift correlation (small molecules, low fields)	ROESY	ROESYPH
H ^{···} H	¹ H/ ¹ H non bound structural neighbor, through space chemical shift correlation (large molecules, proteins)	NOESY	NOESYPH

In most of the 2D parameter sets there is a spectral width optimization implemented. So if you acquire the corresponding 1D experiments in the previous experiment number the spectral width for the 2D will be optimized according to the 1D information.

A complete list of parameter sets can be called up by typing **rpar** without a following name. The nomenclature of the parameter sets follows the rules for the nomenclature of the pulse programs. They can be found in the file: \$TopSpinHome/exp/stan/nmr/lists/pp/Pulprog.info

¹ z-gradient hardware required

1.3.3 TopSpin parameters and commands

A list of commonly used acquisition and processing commands and parameter names as well as a description of the corresponding command or parameter is given in short in the tables below.

Table 1.2: General Commands and AU Programs

setres	customize the TopSpin interface
edmac	edit or create a TopSpin macro
edau	edit or create a TopSpin AU program
edpul	edit or create a TopSpin pulse program
xau listall_au	create a file called "listall" in your home directory with a list of all available AU programs including short descriptions
edcpul	edit the current pulse program

Table 1.3: Data Set Related Commands

edc, new	create a new data set, experiment number or processing number
xau iexpno	copy the current experiment number including all parameters to the consecutive experiment number
wrpa	copy of the current data set including the spectra
re	move to a specific experiment number within the data set
rep	move to a processing number within the experiment number
browse	browse the data set directories
search	find a specific data set
wpar	save the current parameters
rpar	select and read a predefined parameter set

Table 1.4: Acquisition Parameters

ns	number of scans
ds	number of dummy scans
td	Time domain, number of acquired data points
sw	sweep width in ppm
aq	acquisition time
o1p	transmitter frequency of f1 channel in ppm
o2p	transmitter frequency of f2 channel in ppm
rg	receiver gain
pulprog	definition of the pulse program
aunmp	definition of the acquisition AU program

Table 1.5: Acquisition and Pre-acquisition Commands

edhead	define the current probehead
edprosol	define probehead specific pulse lengths and power levels (3.0)
getprosol	use probehead specific pulse lengths and power levels in the current pulse program (3.0)
xau pulse	calculate the power level from pulse lengths and vice versa
edasp	configure the routing of the spectrometer
edcpul	open the current pulse program in a text editor window
eda	edit all acquisition parameters
ased	edit the acquisition parameters that are relevant for the current pulse program
spdisp	open the graphical pulse program editor (3.0)
dpa	display all status parameters for the acquisition
wbchan	select the wobbling channel for tuning and matching

wobb	tuning and matching the probe
atma	automatic tune and match the ATM probe
atmm	manually tune and match the ATM probe
edsolv	define solvent parameters
edlock	define lock parameters for probhead and solvent
lock	automatically lock on solvent (parameters defined in edlock)
lockdisp	open the lock display window
rsh	select and read shim values
gradshim	start the gradient shimming subprogram
wsh	save the current shim values
edte	open the temperature control window
edau	select or edit AU programs
stdisp	open the shape tool
expt	estimate the experiment time
rga	automatically adjust the receiver gain
zg	start acquisition
xaua	start the acquisition AU program (this also starts the acquisition)
gs	interactive adjustment of acquisition parameters
tr	data transfer during acquisition
halt, stop	stop the acquisition
kill	kill a specific process

Table 1.6: Processing Parameters

si	size of the real spectrum
phc0, phc1	parameters for zero order and first order phase corrections
lb	line broadening factor for em
aunmp	definition of the processing AU program

Table 1.7: Processing Commands

edp	edit all processing parameters
dpp	display all status parameters for processing
ft	Fourier transform the current data
em	apply exponential window function
ef	combined command of ft and em
phase	set the phase correction defined by phc0 and phc1
apk	automatically phase correct the spectrum
abs	automatically baseline correct and integrate the spectrum
efp	combined command of ft , em and phase
sr	spectral referencing
sref	automatically calibrate the spectrum
edc2	select a second and a third data processing number
dual	invoke the dual display
edo	select an output device
edg	edit all graphics and plotting parameters
view	plot preview
plot	start the plot program

Table 1.8: Pulse Program Specific Parameters

pl1	f1 channel - power level for pulse (default)
pl2	f2 channel - power level for pulse (default)
pl9	f1 channel - power level for presaturation
pl10	f1 channel - power level for TOCSY-spinlock
pl11	f1 channel - power level for ROESY-spinlock
pl12	f2 channel - power level for CPD/BB decoupling

pl14	f2 channel - power level for cw saturation
pl15	f2 channel - power level for TOCSY-spinlock

sp1	f1 channel - shaped pulse for selective excitation or f1 channel - shaped pulse for water flipback
sp2	f1 channel - shaped pulse 180 degree or f2 channel - shaped pulse 90 degree (on resonance)
sp7	f2 channel - shaped pulse 180 degree (off resonance2) or f2 channel - shaped pulse 180 degree (adiabatic) or f1 channel - shaped pulse for wet

p0	for different applications i.e. f1 channel - variable flip angle high power pulse in DEPT
p1	f1 channel - 90 degree high power pulse
p2	f1 channel - 180 degree high power pulse
p3	f2 channel - 90 degree high power pulse
p4	f2 channel - 180 degree high power pulse
p6	f1 channel - 90 degree low power pulse
p11	f1 channel - 90 degree shaped pulse (selective excitation or water flipback/watergate or wet)
p15	f1 channel - pulse for ROESY spinlock
p16	homospoil/gradient pulse
p17	f1 channel - trim pulse at pl10 or pl15
p18	f1 channel - shaped pulse (off resonance presaturation)

d0	incremented delay (2D)	[3 usec]
d1	relaxation delay 1-5 * T1	
d2	1/(2J)	
d3	1/(3J)	
d4	1/(4J)	
d6	delay for evolution of long range couplings	
d7	delay for inversion recovery	
d8	NOESY mixing time	
d9	TOCSY mixing time	
d11	delay for disk I/O	[30 msec]
d12	delay for power switching	[20 usec]
d14	delay for evolution after shaped pulse	
d16	delay for homospoil/gradient recovery	
d17	delay for DANTE pulse-train	
d18	delay for evolution of long range couplings	
d19	delay for binomial water suppression	
d20	for different applications	

cnst0	for different applications
cnst1	J (HH)
cnst2	J (XH)
cnst3	J (XX)
cnst4	J (YH)
cnst5	J (XY)
cnst11	for multiplicity selection
cnst12	for multiplicity selection

vc	variable loop counter, taken from vc-list
vd	variable delay, taken from vd-list

l1	loop for MLEV cycle (((p6*64) + p5) * l1) + (p17*2) = mixing time
l2	loop for GARP cycle l2 * 31.75 * 4 * p9 => AQ
l3	loop for phase sensitive 2D or 3D using States et al. or States-TPPI method l3 = td1/2
l4	for different applications i.e. noediff

Note that the default units for pulses are microseconds (u), the units for delays are seconds (s), but one can always enter a value combined with a unit to define a time slot in TopSpin. The nomenclature here is: **s** = seconds, **m** = milliseconds and **u** = microseconds. For example to set the value of **d1** to **500m** would define **d1** to last for half a second.

The complete information on the nomenclature and default usage of the pulse program parameters can be found in:

\$TopSpinHome/exp/stan/nmr/lists/pp/Param.info

The nomenclature and description of the standard pulse programs and predefined parameter sets can be found in:

\$TopSpinHome/exp/stan/nmr/lists/pp/Pulprog.info

Acquisition, processing and plotting commands can be given either in the TopSpin command line or via menu selection. Examples are **zg**, which starts the acquisition, **ft** which performs a Fourier transformation on the current data or **apk** which invokes the automatic phase correction.

Another possibility to manage different task in TopSpin are AU programs. They handle many routine jobs and can be selected or edited by the **edau** command. AU programs have to be compiled before first usage. Compile and start AU Programs by entering **xau** followed by the program name.

TopSpin also offers extensive online documentation, which can be accessed via the help menu in the TopSpin menu bar.

1.4 Sample Preparation

An accurate sample preparation can prevent many nuisances, therefore you should pay maximum attention on this. The following points should be considered:

- Use only clean and dry **sample tubes** to prevent contamination. Scratches or poor quality tubes may result in difficulties with shimming.
- The **solvent** must be deuterated to prevent intense proton signals and for locking. If you need to observe OH- or NH-protons, the solvent should be free of exchangeable protons. In cases where you need to run such spectra in a solvent with exchangeable protons, you can use a mixture of 5-10% deuterated and 90-95 % non-deuterated solvents.
- The **amount of the compound** you should use depends on the size of the molecule and the type of experiment you want to run. For a medium-sized organic molecule an amount of ½ - 1 mg is fully sufficient for a 1D proton experiment, whereas you should better use 2 – 5 mg if you also want to run direct observe carbon spectra.

- The optimum **filling height** of the sample tube is 4 cm, corresponding to about 0.6 ml solvent for 5 mm and 4 ml for 10 mm tubes. Using too little solvent results in shimming problems. You can minimize necessary shimming between different samples, if you always use the same filling height.
- The solution should be **clear and homogenous**. Precipitations should be filtered off, concentration gradients should be prevented by shaking the tube after adding additional solvent or compound.
- Adjust the sample tube in the spinner using the sample gauge as a meter. For most probes, the appropriate **sample depth** is about 2 cm (the sample depth is noted in the binder coming with the probe). If you use less than 4 cm filling height, you should adjust the sample in a way that the solution is centred around the 0-line of the sample gauge.
- Make sure, that the tube is held tightly by the **spinner**, for high or deep temperature experiments use the ceramic spinner. If you are running experiments with spinning, make sure, that the reflectors on the spinner are clean. This is important for maintaining the correct spinning rate.
- Wipe the sample tube **clean** before inserting it into the magnet.
- Turn on the lift with the “Lift” button on the BSMS panel or by typing **ej** on the command line. Place the sample with the spinner on the air cushion and press the “Lift” button again or type **ij**, respectively, to insert the sample.


1.5 Tuning and Matching

In a probehead there are resonant circuits for each nucleus indicated on the probehead label (e.g., one for ^1H and one for ^{13}C in a dual $^1\text{H}/^{13}\text{C}$ probehead; one for ^1H and one for a wide range of nuclei in BBO or BBI probeheads). There is also a resonant circuit for the lock nucleus, but the standard user will never need to adjust this, so we will ignore it in the following section. Each of the circuits has a frequency at which it is most sensitive (the resonance frequency). Once the sample is inserted, the probehead should be tuned and matched for these individual frequencies.


Tuning is the process of adjusting this frequency until it coincides with the frequency of the pulses transmitted to the circuit. For example, the frequency at which the ^1H resonant circuit is most sensitive must be set to the carrier frequency of the ^1H pulses (which is **sfo1** if the ^1H circuit is connected to the f1 channel, **sfo2** if it is connected to the f2 channel, etc.). Matching is the process of adjusting the impedance of the resonant circuit until it corresponds with the impedance of the transmission line connected to it. This impedance is $50\ \Omega$. Correct matching maximizes the power that is transmitted to the coil. A probehead is said to be tuned and matched when all of its resonant circuits are tuned and matched. Once a probehead has been tuned and matched, it is not necessary to retune or rematch it after slight adjustments of the carrier frequency, since the probehead is generally tuned and matched over a range of a couple of hundred kHz. On the other hand, large adjustments to the carrier frequency, necessary when changing nuclei, warrant retuning and rematching of the probehead. Thus, a broadband probe needs to be retuned

and rematched each time the heteronucleus is changed. Also a change of the solvent shows some effect on the tuning and matching, so you should always perform these actions with the sample tube inserted in the magnet and eventually retune and match after a solvent change. This is especially important for the proton channel as the solvents influence is larger for higher resonance frequencies than for the lower ones.

1.5.1 Tuning and Matching on ATM Probes

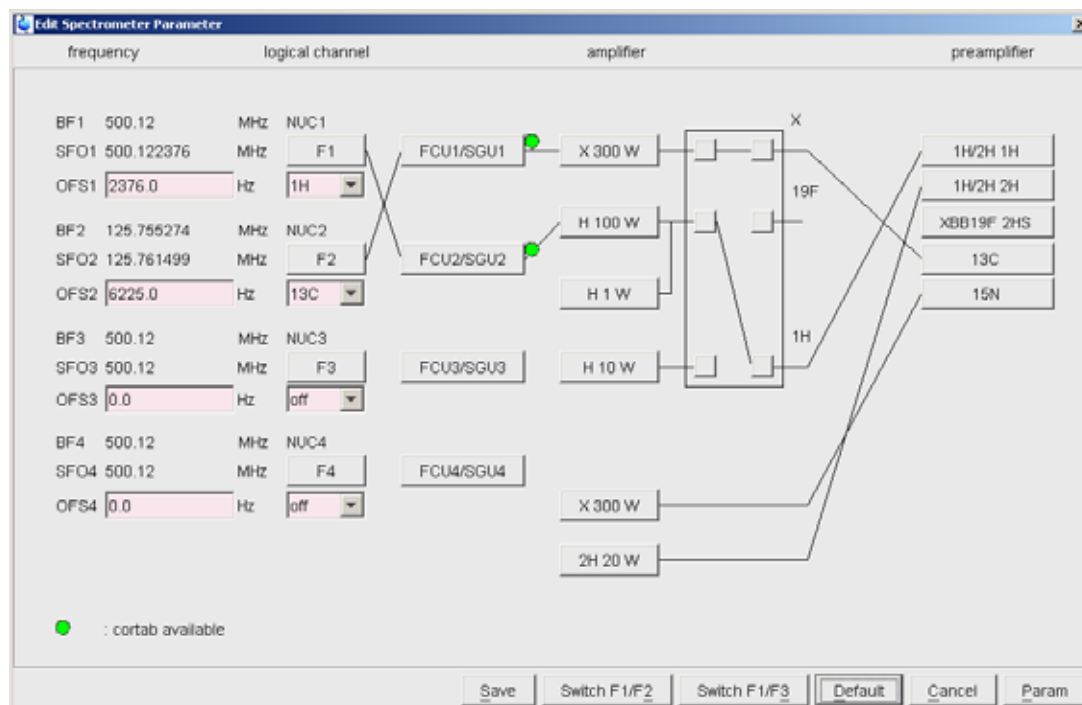
If you have an ATM probe, enter **edasp** or press the button  in the AcquiPars menu of the main window and set the spectrometer parameters for the channels that should be matched and tuned. For ^1H on channel F1 and ^{13}C on channel F2 enter the following values (Figure 1.3):

NUC1 ^1H
 NUC2 ^{13}C
 NUC3 OFF

This automatically sets **sfo1** to a frequency appropriate for ^1H and **sfo2** to the corresponding ^{13}C frequency for tuning and matching. Exit **edasp** by clicking .

Type **atma**. This will invoke the automatic tune and match program for all nuclei that were selected previously in **edasp**. Therefore it is not necessary to tune and match manually.

Figure 1.3: The channel selection window.



1.5.2 Tuning and Matching ¹H (non ATM Probes)


If the NMR experiments to be performed are ¹H homonuclear experiments (e.g., ¹H 1D spectroscopy, COSY, NOESY, or TOCSY), only the ¹H circuit of the probehead has to be tuned and matched.

Make sure that the sample is in the magnet, and the probehead is connected for standard ¹H acquisition. Note that there is no special configuration for tuning and matching. It is recommended to tune and match without sample spinning.

Set the Parameters

Enter **edasp** or press the button  in the AcqPars menu of the main window and set the following spectrometer parameters:

```
NUC11H  
NUC2OFF  
NUC3OFF .
```

This automatically sets **sfo1** to a frequency appropriate for ¹H tuning and matching. There is no need to adjust **sfo1** carefully now. Exit **edasp** by clicking .

Start Wobbling

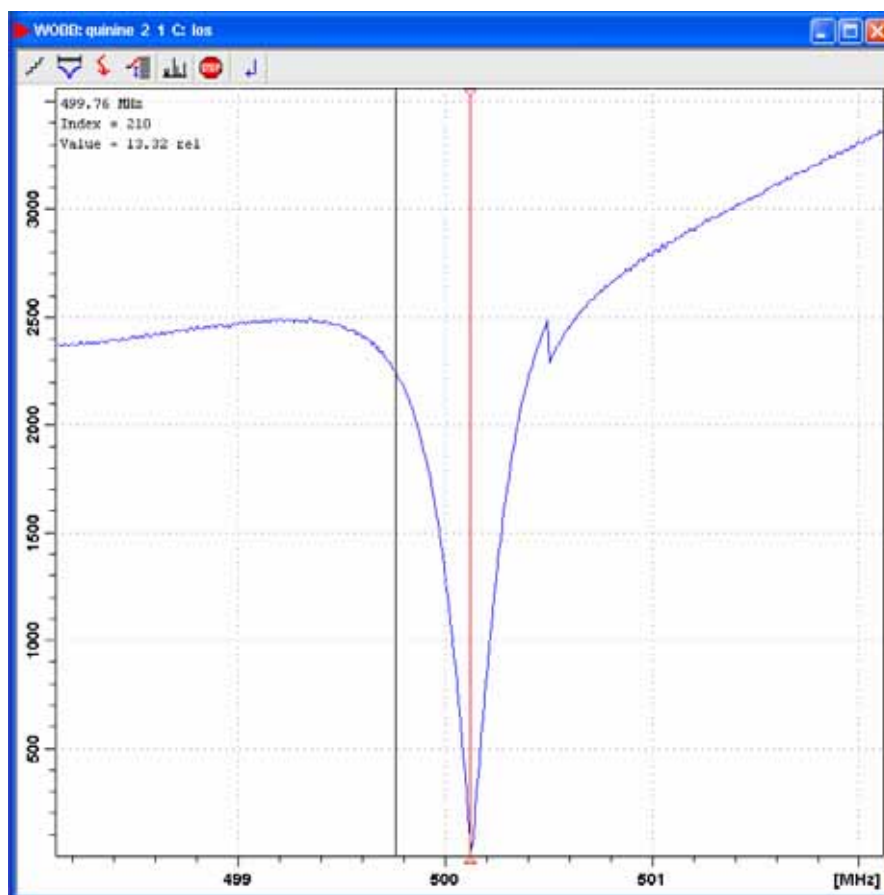
Tuning and matching are carried out simultaneously. During wobbling, a low power signal is transmitted to the probehead. This signal is swept over a frequency range determined by the parameter **wbsw** (the default value is 4 MHz) centered around the carrier frequency (i.e., **sfo1**, **sfo2**, etc., depending on which nucleus is being tuned/matched). Within the preamplifier (High Performance Preamplifier Assembly or HPPR), the impedance of the probe over this frequency range is compared to the impedance of a 50 Ω resistor. The results are shown both on the LED display of the HPPR and in the acquisition submenu of TopSpin. Both displays show the reflected power of the probehead versus the frequency of the signal. The user observes either one or both of these displays while tuning and matching the probehead.

Before starting the wobbling procedure, ensure that no acquisition is in progress, e.g., enter **stop**.

Enter **acq** to switch to the acquisition window of TopSpin, if it is desired to use this to monitor the tuning and matching.

Start the frequency sweep by typing **wobb**. The curve that appears in the acquisition window is the reflected power as a function of frequency. Unless the probehead is quite far from the correct tuning and matching, there will be a noticeable dip in the curve. When the ¹H circuit is properly tuned, the dip will be in the center of the window, denoted by the vertical marker; and when the circuit is properly matched, the dip will extend all the way down to the x axis (Figure 1.4). Similar information is conveyed by the LED display on the HPPR. The horizontal row of LED's indicates tuning and the vertical row matching. When the circuit is properly tuned and matched, the number of LEDs is minimized. This usually means that only green LED's are lit in both the horizontal and vertical displays.

Figure 1.4: Wobbling curve as shown in the acquisition window.





Tune and Match

Adjust the tuning and matching screws (labeled T and M) at the base of the probehead. The screws are having the same color as the nucleus on the front panel of the probehead and those for the ^1H circuit are usually yellow.

Note that the screws have a limited range and attempting to turn them beyond this range will damage the probehead.

Since there is an dependence between tuning and matching, it is generally useful to adjust the T and M screws in an iterative fashion. Turn the M screw until the dip is well matched at some frequency (the dip extends to the x axis and the number of LED's lit in the vertical HPPR display is minimized). Most likely this will not be the desired frequency. Adjust the T screw slightly to move the dip towards the center of the window, or equivalently, to reduce the number of LED's lit in the horizontal HPPR display. Rematch the dip by adjusting the M screw again. Note that it is possible to run out of range on the M screw. If this happens, return M to the middle of its range, adjust T to get a well matched dip at some frequency, and walk the dip towards the correct frequency as described above.

As mentioned above, ideal tuning and matching is when the dip is centered in the window and extends to $y = 0$ (the x axis) on the acquisition window (Figure 1.4), or equivalently, when the number of LED's lit on the preamplifier is minimized in both the vertical and horizontal display.

When the ^1H circuit is tuned and matched, exit the wobble routine by typing **stop** or pressing the button . Click on  to exit the acquisition window and return to the main window.

1.5.3 Tuning and Matching ^{13}C (non ATM Probes)


Since most ^{13}C experiments make use of ^1H decoupling, besides ^{13}C the ^1H should be tuned and matched as well. When tuning and matching a probehead with multiple resonant circuits, it is best to tune and match the lowest frequency circuit first. Thus, when tuning and matching a probehead for both ^1H and ^{13}C , first do the ^{13}C and then the ^1H adjustments. However, if you proceed with the procedure as described below, TopSpin will take care of this by showing the lowest frequency wobbling curve first and going then to the higher frequencies whenever you change the channel.

Make sure that the sample is in the magnet, and the probehead is connected for the appropriate experiment. It is recommended to tune and match without sample spinning.

Set the Parameters

Enter **edasp** or press the button  in the AcqPars menu of the main window and set the following spectrometer parameters:

```
NUC113C  
NUC2 1H  
NUC3OFF .
```


This automatically sets **sfo1** and **sfo2** to a frequency appropriate for ^{13}C and ^1H tuning and matching. Exit **edasp** by clicking .



Start Wobbling, Tune and Match

Ensure that no acquisition is in progress, enter **stop**.

Enter **acqu** to switch to the acquisition window, if this will be used to monitor the tuning and matching.



Start the frequency sweep by typing **wobb**. The curve that appears in the acquisition window is for ^{13}C . Adjust the tuning and matching following the guidelines given above for ^1H . Note that some probeheads (e.g., broadband probeheads) have sliding bars instead of screws, one set labeled tuning and another labeled matching. Set the tuning and matching sliding bars to the values indicated for ^{13}C on the menu. Adjust the tuning and matching bars until the dip is well tuned and matched at some frequency as described above for ^1H .

Now the channel can be switched to the ^1H channel by clicking the channel select button . Adjust the tuning and matching for the protons with the screws while monitoring it via the LED's on the HPPR or the display on the computer.

Once the probehead is tuned and matched for ^{13}C and ^1H , exit the wobble routine by typing **stop** or pressing the button . Click on  to exit the acquisition window and return to the main window.

1.6 Locking

Before running an NMR experiment, it is necessary to lock and shim the magnetic field.

In the acquisition status bar, there is a small icon, displaying either the lock level or giving a number, which belongs to the height of the lock level in percent. The desired display can be toggled in the user preference dialog window that can be started with the command **setres**. To get a bigger display in the main window you can either press the button  in the menu bar or enter **lockdisp** on the command line. This opens a window in which the lock trace appears. You can detach this window from the main TopSpin window by clicking the button  in the menu bar of the lock window.

1.6.1 Autolock

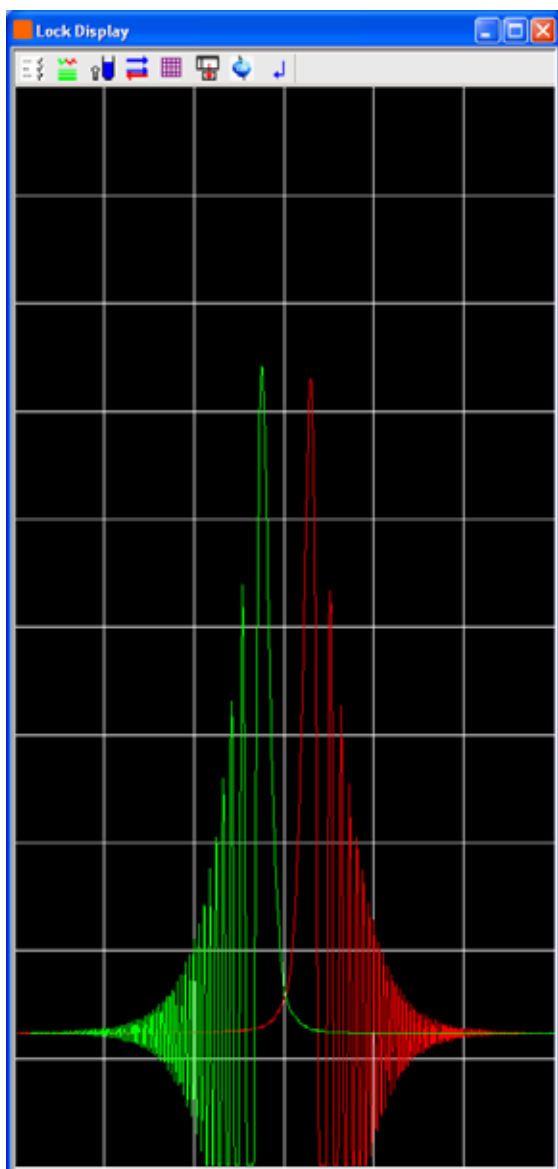
The most convenient way to lock is to use the TopSpin command **lock**. To start the lock-in procedure, enter **lock** and select the appropriate solvent from the list. Alternatively, enter the solvent name together with the lock command, e.g., **lock cdcl3**. During lock-in, several parameters such as the lock power, the field value, and the frequency shift for the solvent are set according to the values in the lock table. This table can be edited using the command **edlock**. Note that the lock power listed in this table is the level used once lock-in has been achieved. The field-shift mode is then selected and autolock is activated. Once lock-in is achieved, the lock gain is automatically adjusted to a value that the lock signal is visible in the lock window. At this point the message “lock: finished” appears in the status line at the bottom of the window.

The lock-in procedure outlined above sets the frequency shift to the exact frequency shift value for the given solvent as listed in the **edlock** table. It also sets the field value to the value listed in the **edlock** table and then adjusts it slightly to achieve lock-in (the absolute frequency corresponding to a given ppm value no longer depends on the lock solvent). Following this lock-in procedure, the **solvent** parameter in the **eda** table is set automatically, which is important if you wish to use the automatic calibration command **sref** (see chapter 2.3.2).

1.6.2 Adjustment of field and lock phase and power

If the lock settings have not been adjusted for a long time or when changing the probehead it is possible that some problems during the locking procedure occur. This is mostly due to inappropriate values for the magnetic field or the lock phase. To check these values, it is best to monitor the sweep wiggles that will be displayed, if the sample is not locked, but the magnetic field is swept. If the lock phase and the field are set correctly, the signal is centered with both inner wiggles pointing up and without any phase distortion (Figure 1.5).

Figure 1.5: Lock display showing a signal with good phase and field value.



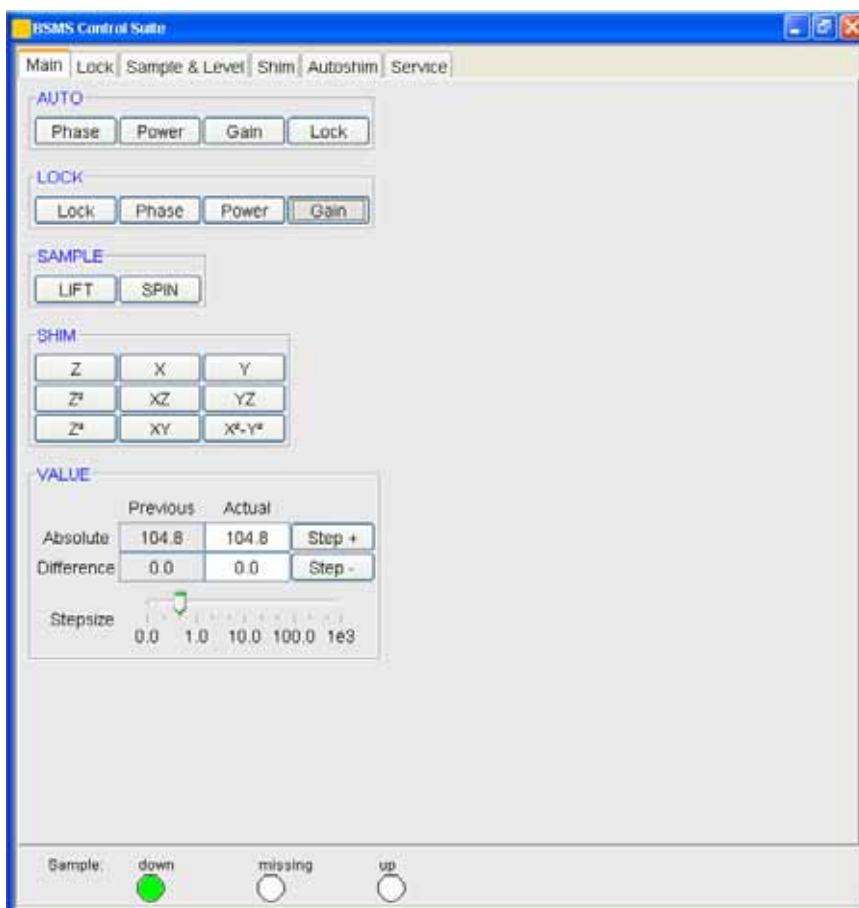
However, the signal may not be phased or centered with respect to the central line of the grid. If these deviations are small, autolock may still be able to find the signal and to lock in but if they are becoming too large, it will fail.

To adjust these values it is best to use the BSMS panel. If this is not available on your spectrometer, you can get a window displaying all BSMS functions with the command **bsmsdisp** (Figure 1.6). Switch of the lock by pressing the “Lock” button. Sweep will be automatically turned on then.

To adjust the field, press the “Field” button on your BSMS and turn the knob until the signal is centered. You can alter the sensitivity of the changes with the “Fine” button on the lower right side of the BSMS panel.

If using the BSMS display, it is necessary to go to the Lock parameters by pressing the Lock Tag in the menu bar of the display window. Then press the Field button and adjust the value with the step+/step- buttons on the bottom of the window. The step size can be altered with the slider.


Figure 1.6: The BSMS display window




The phase can be adjusted by clicking the Lock Phase button and changing the value with the knob or stepwise, respectively. The base around the central wiggles should be flat. Note that these central wiggles need to be positive, otherwise the phase is wrong by 180° and the system can not lock in! If the original phase is reasonably close to the correct value, lock-in can be achieved and the phase can also be adjusted using autophase or manually by changing the lock phase to reach a maximum lock level.


In some cases, the lock power level listed in the **edlock** table is set too high leading to a saturation of the lock signal. Usually, lock-in can be achieved, but the signal oscillates due to saturation. A quick fix is simply to reduce the lock power manually after lock-in.

After adjusting these values it makes sense to change them in the **edlock** table where all parameters used during the automatic lock procedure are stored. If this is not done the current sample can be locked in by pressing the "Lock" button on the BSMS or the BSMS panel or by typing **lock -noauto** on the command line. However the next time automatic locking tried the program will read in the wrong settings still kept in the **edlock** table and autolock will fail again. Therefore it is strongly recommended to change the settings according to the optimized values. To start the lock parameter editor, type **edlock** on the command line. A window will open that shows the actual settings for each solvent.

To adjust the field value press . The actual value will then be read in from the BSMS. This value only depends on the magnetic field. The more the magnet is drifting, the faster the field value will be changing. Hence this adjustment may be necessary more often on a freshly installed magnet.

The lock phase is probe dependant. Therefore a different value is stored for each probe. However, the value is independent of the solvent. After adjusting the phase, fill in the value as the phase of the first solvent and press the button . The value will be copied to all other solvents.

The lock power is solvent dependant. Therefore only individual changes should be made for each solvent that needs some power adjustment. Just type in the correct value found for the power.

After filling in the correct values, leave the lock table by pressing the  button. Note that the **edlock** table can only be edited by the NMR Superuser.

1.6.3 Optimize lock settings (optional)

Once the magnetic field has been locked and shimmed, the user may wish to optimize the lock settings as described below. It is strongly recommended to follow this procedure before running any experiment requiring optimal stability (e.g., NOE difference experiments).

After the field is locked and shimmed, start the auto-power routine from the BSMS keyboard (see Chapter 2 'Key Description' of the BSMS User's Manual). For lock solvents with long T_1 relaxation times (e.g., CDCl_3), however, auto power may take an unacceptably long time and the lock power should be optimized manually. Simply increase the lock power level until the signal begins to oscillate (i.e., until saturation), and then reduce the power level slightly (approximately 3 dB). For example, if the lock signal begins to oscillate at a power of -15 dB, the optimal magnetic field stability can be expected when a level of approximately -18 dB (or even -20 dB) is used. The field stability will be significantly worse if a power level of, say, -35 dB is used instead.

When the lock power is optimized, start the auto-phase routine, and finally the auto-gain routine. Take note of the gain value determined by auto gain. Using this value, select the appropriate values for the loop filter, loop gain, and loop time as shown below in Table 1.9.

Table 1.9: Lock Parameters (BSMS Firmware Version 980930)

Lock RX Gain (after auto gain) [dB]	Loop Filter [Hz]	Loop Gain [dB]	Loop Time [sec]
120	20	-17.9	0.681
	30	-14.3	0.589
110	50	-9.4	0.464
	70	-6.6	0.384
	100	-3.7	0.306
	160	0.3	0.220
90	250	3.9	0.158
	400	7.1	0.111
	600	9.9	0.083
	1000	13.2	0.059
	1500	15.2	0.047
	2000	16.8	0.041

So, for example if auto gain determines a lock gain of 100 dB, the user should set the loop filter to 160 Hz, the loop gain to 0.3 dB, and the loop time

to 0.220 sec (see Chapter 4 'Menu Description' of the BSMS User's Manual for how to set these parameters from the BSMS keyboard).

An automatic adjustment of these values can be done with the loop adjustment routine that can be started with the command **loopadj**.

1.7 Shimming

If the sample has been changed, the first step after locking is shimming the magnetic field. If the instrument has been used recently, you can start with the shim values still set from the previous sample. A safer way is to read in an appropriate shim file that was recently stored with the same probe by entering the command **rsh** and selecting the file from the menu. This will deliver you a good starting value.

1.7.1 Manual Shimming

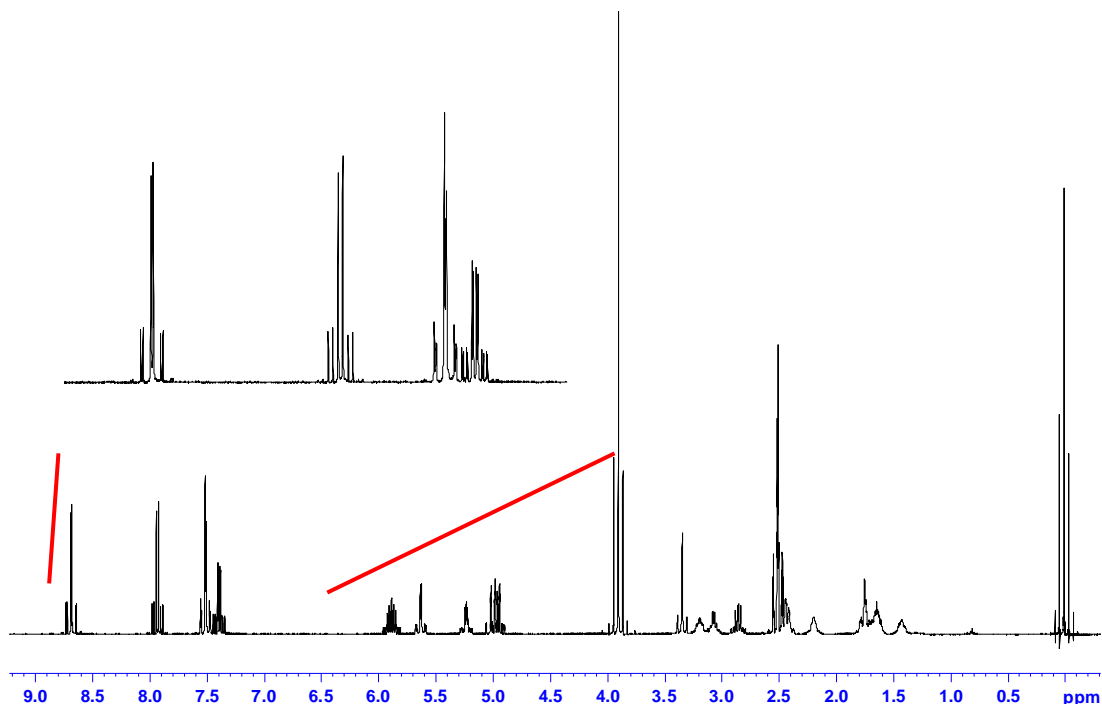
To improve the shim it is mostly sufficient, to adjust only z and z^2 . Activate the buttons on the BSMS panel and turn the knob in order to increase the lock level displayed in the lock window. Keep in mind, that different shims will slightly affect each other, so after adjusting z , go on to z^2 and then back to z and so on, until there is no gain any longer. If the resulting spectrum still shows broad or asymmetric lines, you can try to adjust z^3 and z^4 . Also in this case you have to readjust z and z^2 in between! Keep in mind, that the higher shim values will only affect the outer parts of the sample volume and hence will only lead to narrower "feet". A splitting or asymmetry that affects the whole peak height can not be corrected with these shims!

If you are going to run a spectrum with spinning, you should do the shimming on the spinning sample as well, because the sample position is slightly different, when the spinning air is turned on.

If the starting shim file was rather poor, it may happen, that you observe large spinning sidebands in your spectrum (Figure 1.7). In such a case you will have to adjust the off axis shims, that do affect the homogeneity of the magnetic field perpendicular to the field direction. To do this, stop sample rotation, readjust z and z^2 and repeat the procedure described above with x and y and, eventually, xz and yz .

Never change any off axis shims, while spinning the sample!

Figure 1.7: large spinning sidebands in a 1D proton spectrum with wrong setting of the off axis shims.



After yielding a good shim, you can store the current shim settings by entering the command **wsh** and giving the file a name. It is a good idea to readjust the basic shim of the system regularly every few months and store it with the date. In this way, every user will always be provided with a reasonable starting shim file.

1.7.2 Gradient Shimming

If you have a gradient probe, you can also use the gradient shimming tool, which can be setup according to the instructions given in the gradient shimming manual. If it is once setup, you can just start it by typing **gradshimau** on the command line. This will start the standard gradient shimming routine that was stored as automation method – usually this means on-axis shimming on deuterium. Therefore a deuterated solvent is needed for this method.

Of course it is also possible to use gradient shimming for solvents with high non-deuterated solvent content, e.g. 90% H₂O / 10% D₂O. However, the deuterium signal will be rather weak and therefore the shimming procedure will not be very reliable if you use it. In such a case you should start the procedure with the command **gradshim**. A window will open, where you can chose the dimensionality and the nucleus you want to shim on. For on-axis shimming on proton chose the option 1D and press the button . Additionally to on axis shimming you can also perform on- and off axis shimming on protonated solvents. To do so, chose the option 3D and press the button .

2 The 1D Proton Experiment

2.1 General information about the experiment

The 1D Proton experiment is the most commonly used high resolution NMR experiment since it is very simple, fast and yields a variety of information.

- 1.) Proton chemical shift information can be used to distinguish different functional groups.
- 2.) Integration of the proton signals yield information about the number of protons within one signal.
- 3.) The multiplicity of the signals contains information on scalar coupling partners and thus the constitution of the observed molecule.

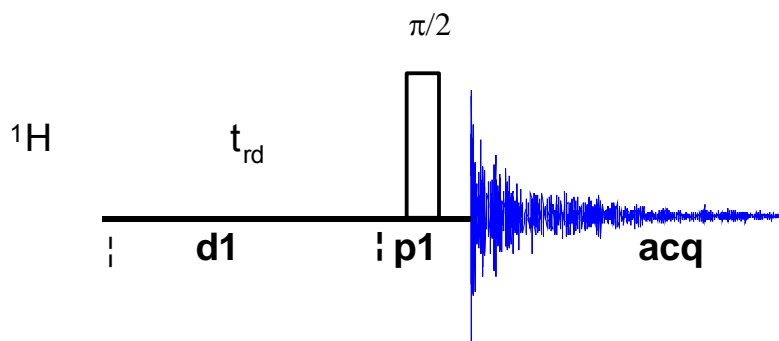
The 1D proton experiment is often the only experiment – possibly along with a ^{13}C 1D experiment – when the structure of a small molecule has to be verified. Since ^1H is the most sensitive nucleus for NMR experiments, it is the fastest and most sensitive high resolution NMR experiment. Therefore it is advisable to run a quick ^1H experiment also as a preparation for any other NMR experiment. This allows you to check the status of your sample, and to examine the intensity of the NMR signals and thus to assess the experiment time of other, more complicated NMR experiments.

2.1.1 Pulse sequence and a few NMR details

The pulse program or pulse sequence used here is a simple one-pulse sequence consisting of the recycling delay **d1** and either a 90° - or $\pi/2$ - pulse (**p1**) or – considering the Ernst angle – a 30° pulse (**p1*0.3**) for faster multi-scan experiments. This is then followed by the acquisition time. The pulse program is called **zg** or **zg30** respectively when a 90° or 30° pulse is used.

A graphical representation of the pulse program is given in Figure 2.1. Note that neither the time intervals nor the power levels are drawn to scale. For example **d1** is typically a few seconds while **p1** is typically a few microseconds.

Figure 2.1: 1D ^1H NMR one-pulse sequence



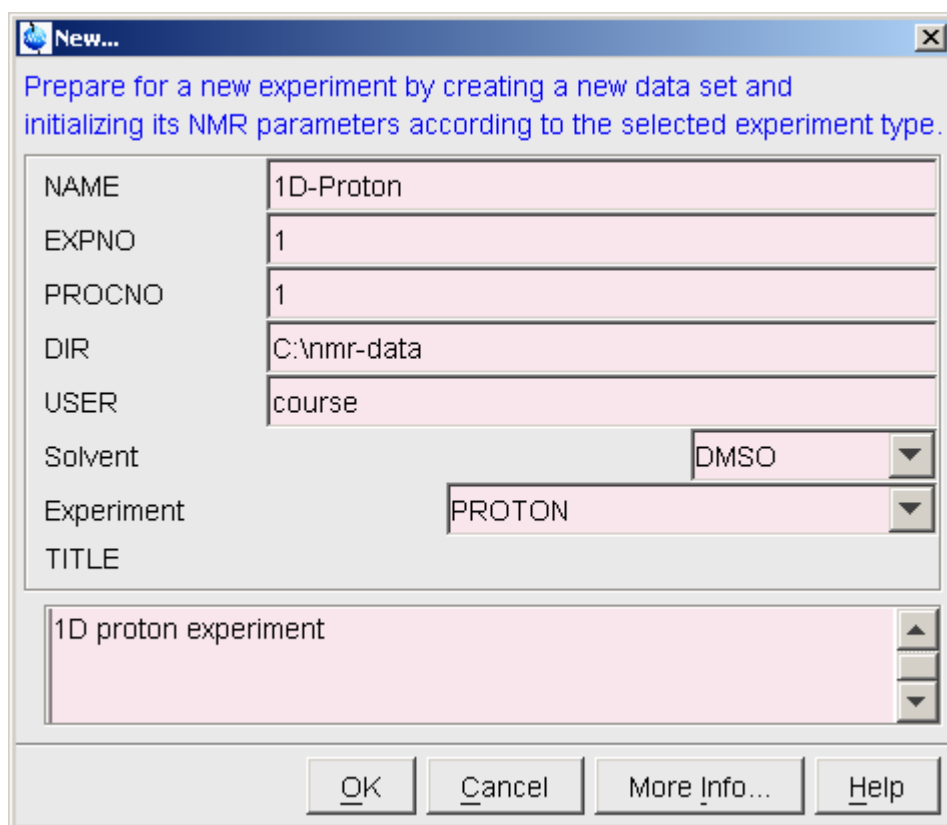
2.2 Preparation and Acquisition

The steps that belong to the spectral acquisition are all arranged in the NMR spectra acquisition guide, which may be invoked from the **Acquisition** → **Data Acquisition Guide** menu.

2.2.1 Data acquisition step by step

- Make sure that the sample tube is properly adjusted in the spinner if needed and insert it into the magnet. (For more information on sample preparation and handling, please refer to chapter 1.4 on page 7).
- If needed, make a new dataset, type **edc** or **new** or select **File** → **New** from the menu.

Figure 2.2: TopSpin dataset editor



The screenshot shows a dialog box titled "New..." with the following fields and values:

NAME	1D-Proton
EXPNO	1
PROCNO	1
DIR	C:\nmr-data
USER	course
Solvent	DMSO
Experiment	PROTON
TITLE	1D proton experiment

Buttons at the bottom: **OK**, **Cancel**, **More Info...**, **Help**.

Here, the dataset name, the experiment number (**EXPNO**), the processing number (**PROCNO**), the directory and the user name are entered. All of these entries will become directories on the respective hard-disk. (For more information on directory structures, refer to chapter 1.3.1).

You may also choose the correct solvent in the **Solvent** field and select a parameter-set here in the **Experiment** field. The experimental parameters for acquisition, processing, plotting and output will be loaded from the selected parameter-set as if you would have typed **rpar**. You may also give a title.

- If you have not selected a parameter-set yet (see above), type **rpar PROTON all**. This will select the PROTON standard

parameters, which may be used as they are or which may be adjusted to your needs later. (For more information on parameter-sets, refer to chapter 1.3.2.)

- Lock the sample by typing **lock** and select the correct solvent.
- Match and tune the sample either manually by typing **wobb** and physically adjusting the matching and tuning sliders or screws on the probe – if you do not have an ATM probe – or automatically by typing **atma** – if you do have an ATM probe.
- If you would like to compensate for bad off-axis homogeneity but would not like to shim the off-axis shims, you may spin the sample. Press the spinning button on the BSMS keyboard or type **ro**. Spinning will lead to spinning sidebands in the spectrum (see also section 1.7) and can not be used in 2D experiments.
- Shim the sample either manually or by using the gradient shimming automation routine, type **gradshimau**.
- Type **getprosol** to load the probe dependent parameters!
- Adjust acquisition parameters or start the acquisition. We recommend that you use the automation mode by typing **xaua**. You may also start the receiver gain adjustment manually (type **rga**) and then start the acquisition and type **zg**.

2.2.2 Important acquisition parameters for this experiment

There are some acquisition parameters that may be modified for this experiment. The values of the parameters may be edited by clicking the AcqPars tag in the main window. You may access the full set of all acquisition parameters also by typing **eda** or a reduced set, where only parameters are displayed that are relevant for the selected pulse program by typing **ased**. Each parameter may also be accessed by typing it's name in lower case letters.

Table 2.1: Acquisition parameters that may be adjusted from the default parameter-set

Parameter	Explanation	Comments and possible values
PULPROG	pulse program for the acquisition	Use the zg pulse program with the 90° pulse angle for maximum signal to noise in one scan experiments. For more scans, we recommend to use zg30 with 30° pulse angles, since the signal integration is more reliable also with shorter recycle delays d1 .
NS	number of scans	Typically 1 – 32 but the value may be increased if more signal to noise is desired. More scans = longer experiment time.
DS	dummy scans	Typically 0 – 2
SW, TD, AQ	spectral width, time-domain,	These parameters are inter-dependant. sw (in ppm, or correspondingly swh in

	acquisition time	Hz) defines the width of the spectral window and it has to be large enough to incorporate all peaks of the spectrum. Typically all ¹ H peaks fall within 20ppm but it may be less. td should be chosen in a way that aq is about 3 seconds long. Unless it is a very slowly relaxing molecule, this is sufficient.
O1P	transmitter frequency	o1p (in ppm or o1 in Hz or sfo1 in MHz) defines the center of the spectral window (sw or swh). For 1H, about 5ppm is a typical value for o1p .
D1	recycling delay between two scans	Using 90° pulses, d1 + aq should be about 5*T ₁ in order to allow for complete relaxation before the next scan. For 30° pulses, shorter values may be used: typically 1 – 3 seconds.
RG	receiver gain	This is automatically adjusted using the commands xaua or rga .
P1, PL1	probe dependant pulse length and power level	These parameters are dependant on the individual probe and are loaded by the getprosol command.

2.3 Spectral processing

After the spectral acquisition has finished, the data has to be processed. You may do this either automatically using the **xaup** command or manually.

2.3.1 Automatic processing

The command **xaup** will invoke the automation AU program that is stored along with the processing parameters in the **aunmp** parameter. In this case the **aunmp** AU program is called **proc_1d**.

Typing **xaup** will automatically process the data and thus it will generate a phase corrected spectrum, it will also perform a baseline correction and it will do an automatic integration of the peaks. By default, a plot will be created using the plot-layout which is also stored in the processing parameters. For the PROTON parameter-set this layout file is called **1D_H.xwp**.

2.3.2 Manual processing

The acquired data may also be processed manually. The steps that belong to the spectral processing are all arranged in the NMR data processing guide, which may be invoked from the **Processing → Data Processing Guide** menu.

Window function: A window function may be applied to the FID for smoother spectra or to enhance either resolution or signal to noise. The command **em** applies an exponential multiplication to the FID where the related parameter **lb** (line broadening) defines the value of the exponential factor. The

command **gm** applies a gauss function multiplication which takes into account the two gauss factors **lb** and **gb**.


Exponential multiplication enhances signal to noise with the tradeoff of broader lines, while the gauss function enhances the resolution but decreases signal to noise.



For 1D Proton spectra, usually an exponential multiplication is applied with **lb** = 0.3Hz.


Fourier transformation: After the application of the window function, the time domain data has to be Fourier transformed to yield a frequency domain spectrum. This is achieved with the command **ft**. Since exponential multiplication and Fourier transformation is often used consecutively, the command **ef** combines the **em** and the **ft** command.

Phase correction: The resulting spectrum will have to be phase corrected. There are two alternative mathematical algorithms for automatic phase correction procedures. They are executed by the commands **apk** and **apks**, respectively.

If – for some reason – only a part of the spectrum should be taken into account for phase correction, this may be done with the command **apkf**. The left and right limits of the region that shall be considered are defined by the processing parameters **absf1** and **absf2** respectively.

It is also possible to manually phase correct the spectrum. Click the phase correction button  or type **ph** and select **manual phasing** from the dialogue window. The position of the reference- or pivot point is indicated by a red vertical line. By default, the highest peak is defined as the pivot point but if this peak is close to the center of the spectrum, it is advised to select a peak somewhere near the edge of the spectrum as pivot point. Move the cursor over the peak, press the right mouse button and select **Set Pivot Point** from the context menu.

Use zero order phase correction to correct the phase around the area of the pivot point: place the cursor over the  button, hold down the left mouse button and move the mouse up or down. Thus, adjust the 0 order phase value until the peak at the pivot point is positive and the baseline around it is flat. Then adjust the first order phase value in the same way by holding down the left mouse button over the  button. Move the mouse up and down until the peak on the opposite side of the spectrum – with respect to the reference peak – is positive and the baseline around this peak is flat as well.


By clicking the save-and-return button () , the phase correction will be applied to the spectrum and the values for zero- and first order phase correction will be stored to the corresponding processing parameters: **phc0** and **phc1**. These parameters may now be used for phase correction of subsequent spectra by typing the command **pk**.

The command **efp** combines the commands **em**, **ft** and **pk**. Thus it applies an exponential multiplication to the FID (using the **lb** parameter). It then Fourier transforms the data and applies the phase correction values, stored as parameters **phc0** and **phc1**.

Calibration and referencing: The chemical shift ppm axis may be calibrated. The **sref** command automatically looks for a peak at around 0ppm (\pm

0.5ppm) and assumes that this is the TMS or another internal reference substance. It will then calibrate the axis of the spectrum in a way that this peak is at exactly 0ppm. If **sref** does not find a peak at around 0 ppm, it uses the solvent information for the axis calibration.

This method only works unambiguously if you have added TMS or another internal reference compound to your sample and if no peaks from your compound are in the area near 0ppm.

You may also use the manual mode to calibrate the spectrum. Zoom into the peak of interest, which you'd like to set to a certain ppm value (e.g. the residual protonated solvent peak). To zoom into a certain region of a spectrum, hold down the left mouse button in the spectrum display and drag the cursor over the area of interest. Then click on this button  to enter the manual calibration mode.


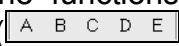

Place the red line of the cursor over the top of the peak that you'd like to use for calibration and click the left mouse button. Enter the desired frequency at the point of the cursor into the calibration window that opens up. (If you have selected the center peak of the DMSO-d5 multiplet for example, you'd enter 2.49ppm here). Click **OK** and you're taken back to the default display and the axis calibration is stored into the processing parameters as the **sr** parameter. This parameter is also adjusted by the **sref** command.

Baseline correction: The baseline of the spectrum may be corrected automatically by the command **abs**. This will then apply a polynomial baseline correction where the order of the polynomial function is defined by the processing parameter **absg**. The value for **absg** may range between 0 and 5. The default value for **absg** stored with the PROTON parameter set is 5.

absd uses an alternative mathematical algorithm than **abs**. It is, for example, used when a small peak lies on the foot of a large peak. In that case, **absd** allows you to correct the baseline around the small peak which can then be integrated. Usually **absd** is followed by **abs**.

Both of these baseline correction commands will also automatically integrate the peaks of the spectrum. To display the integrals determined by one of the above commands, right-click inside the data window and select "Display Properties", then check the entry "Integrals" and click OK.

Automatic baseline correction may also be applied only for parts of the spectrum. The processing parameters **absf1** and **absf2** define the left and the right limit of the spectral region (in ppm), where the baseline correction should be applied. Then use the command **absf** to correct only the selected region.

In order to enter the manual mode for baseline correction, click on the baseline button (). You may also type **bas** and select the option "correct baseline manually". Here you may select different mathematical functions for the baseline (polynomial-, sine- and exponential functions). The corresponding factors for the functions may be adjusted by keeping the appropriate button pressed () while moving the mouse. You may also select individual baseline points and apply a cubic spline correction. By clicking on the difference button () , you may review the result before saving the changes.

2.3.3 Processing parameters

The processing parameters may be displayed by selecting the ProcPars tag in the TopSpin display window or by typing **edp**. Some of these processing parameters govern certain processing commands and may be optimized before the application of the respective processing command. Each parameter may also be accessed by typing its name in lower case letters.

Table 2.2: Processing parameters that may be adjusted from the default parameter-set

Parameter	Explanation	Comments and possible values
SI	Size of the real spectrum	This corresponds to TD in the acquisition parameters. si defines the number of real data points that are used for the processing. If the value for si is larger than $\frac{1}{2}$ td , zero filling is applied since td is given in complex numbers. Zero filling smoothes spectra, so usually si = td . If si < $\frac{1}{2}$ td , then some of the acquired data points are not taken into account!
SR	Spectral reference	This parameter is altered by the spectral referencing. It is 0 if no axis referencing is performed.
LB	Line broadening $\exp(-\mathbf{lb}^*t)$	The lb governs the em and the gm command for the application of window functions. For em , the default value for lb is 0.3Hz. The larger lb , the broader the lines. For gm , lb has to be less than 0.
GB	Gaussian factor $\exp(-\mathbf{gb}^*t^2)^* \exp(-\mathbf{lb}^*t)$	The gb factor governs the gm window function together with lb . gb must be larger than 0 and smaller than 1.
PHC0, PHC1	phase correction for 0 and 1 st order	These values are entered by the phase correction routines and are applied by the processing commands pk , fp , efp .
ABSG	order of the polynomial for abs	$0 \leq \mathbf{absg} \leq 5$. Usually absg = 5 works for most spectra.
ABSF1, ABSF2	left and right limit for absf and apkf	If only parts of the spectrum shall be considered for baseline- or phase correction, these parameters define the limits.

2.4 Post-processing

After the spectra are processed (Fourier transformed, phase corrected, referenced and baseline corrected), peaks may be picked and integrated and the spectrum may be plotted for further interpretation.

2.4.1 Peak picking

Type **pp** in order to enter the peak picking dialog window. There are different options on how to perform peak picking. In order to display the picked peaks, right click in the spectrum display window and select “display properties” from the context menu and tick the box “Peak labels”.

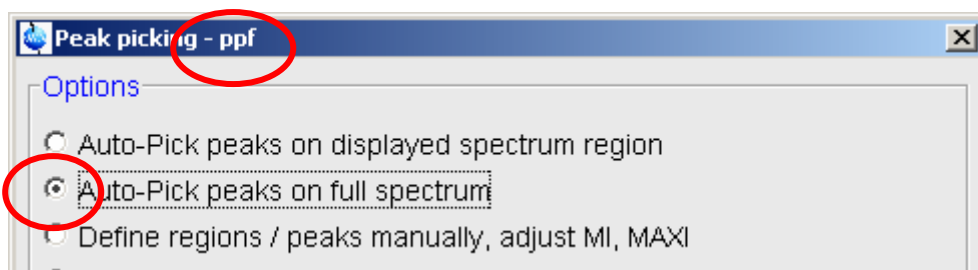
The picked peaks are stored in a peak list text file which may be displayed by selecting the “Peaks” tag in the main window. The peak list is interactive and you may correlate it with the spectrum and display spectrum and peak list at the same time. Right click in the peak list table and select “show spectrum” → “in correlated window” from the context menu. If you now move the mouse cursor over any entry in the list, the cursor in the spectrum will automatically jump to the corresponding peak in the spectrum. The peak list may also be exported as a text file or peak list file. Right click in the peak list window and select the “export” option from the context menu.

Automatic peak picking on the displayed region: Here the parameters **f1p** and **f2p** that define the left and right limit of the peak picking region are automatically set to the display region. One might have to adjust the values for **mi** and **maxi** however. **mi** defines the lower limit from where on peaks are considered as peaks and not as noise. The parameter **maxi** defines the upper limit where peaks that are larger than **maxi** are not considered anymore. If **mi** is too small, the peak picking routine will pick too many peaks in the noise floor. If **maxi** is smaller than the relative intensity of some peaks, these peaks will not be picked.


The automatic peak picking routine, which picks peaks in the full spectrum and which considers the parameters **mi** and **maxi** may also be executed without the graphical interface by typing **ppf**. If also the region – defined by **f1p** and **f2p** – should be considered, the command **pps** applies.



All possible command line commands for each of the options in the **pp** dialog box are displayed in the top frame of this dialog box.


Figure 2.3: peak picking dialog box and command line commands






Defining several regions for the automatic peak picking: You may enter the manual peak picking mode from the dialog box which is invoked by the **pp**

command. Select “Define regions / peaks manually, adjust MI, MAXI”. You may also click on the peak picking button () in the main window in order to enter the manual mode for peak picking and region definition.

In the Manual peak picking mode you may define several regions to be considered for automatic peak picking. These regions can be defined by selecting the “define new peak picking range” button (). Then drag the mouse cursor over the region that you’d like to select. Every peak that is in the box will be considered for automatic peak picking which is started after you are finished defining all regions by clicking the “pick peaks on the defined region” button (). The peaks have to be within the box. Peaks that are larger than the box will not be considered as well as peaks that end below the lower limit of the box.

Save the peaks into a peak list and leave the peak picking mode by clicking the “return, save changes” button (

Manual peak picking: The manual peak picking mode is called up as described above (). With the “define peak manually” button (

All picked peaks are deleted by left clicking on the “delete all peaks” button (



2.4.2 Integration

The integrals of a 1D proton spectrum yield valuable information on the number of equivalent H atoms per peak. It has to be stated though, that the spectrum has to be acquired with a long enough recycle delay **d1** in order to accumulate the signals of fully relaxed protons. Only then, the integration values will make sense. Using the zg pulse program with 90° pulses, **aq + d1** should be about $5 \cdot T_1$, where T_1 is the spin-lattice relaxation time. For typical small, organic molecules T_1 values vary between a few hundred milliseconds to one or two seconds. The zg30 pulse program which uses 30° pulses can be used with shorter **d1** values.

Display and integral lists: The integrals, along with their labels, may be displayed on the spectrum by clicking the right mouse button in the spectrum window and selecting “display properties” from the context menu. Here you’d have to tick the boxes “integrals” and “integral labels”. The “integral labels” actually represent the integral value. They are also stored in an interactive integral table that can be accessed by selecting the “Integrals” tag. If peak picking has been performed before, the integral regions are split up in peaks. Moving the mouse cursor over an integral region or peak will move the cursor position to this integral or peak in the correlated spectrum. Right click in the integral table and select “show spectrum” → “in correlated window” from the context menu. The integral list may also be exported as a comma separated text file. Right click in the integral list window and select the “export” option from the context menu.



The commands **li**, **lipp** and **lippf** also generate and display integral lists as text files. The text files are stored in the datasets as “integrals.txt”, “integrals_lipp.txt” or “integrals_lippf.txt” respectively in the current processing number directory. The **li*** commands display the absolute integral values and regions (**li**), the absolute values and regions along with the corresponding peaks within the integral regions (**lipp**) or the same as **lipp** but for the full spectrum (**lippf**).

Automatic integral region definition and integration: Each spectrum is integrated automatically along with the automatic baseline correction using the command **abs** or **absd**. Integrals may be displayed in the spectrum as described above.

Manual integration and calibration: Often the automatic integration works well but one likes to break down integral regions in a more narrow way or one likes to simply calibrate integrals. This may be done in the manual integration mode which may be accessed by typing **int** and selecting “define integral regions manually” from the dialog window. It may also be accessed by clicking on the “interactive integration” button (). Here, new integral regions may be defined or selected, deleted, calibrated or normalized. Click on the “define new regions” button () and define regions interactively by dragging the mouse cursor over the desired region. Right click for a context menu, where you may select, delete, calibrate or normalize the integral in the region.

Calibration is used to define the multiplicity of the peaks. You may select a peak which you have identified as a CH group for example and calibrate it's integral to 1. All the other integrals within the spectrum will then be referenced to this one. They will have relative intensities according to the number of protons they represent (3 for the three equivalent protons in a CH₃ group for example and so on).

Normalizing will assign a value for the total sum of integrals over all integral regions (e.g. 100%). If you select “normalize” from the context menu, the portion of each region of this sum is displayed (e.g. 23.665 %). This may be very useful to assess the ratio of impurities in the sample or the ratio of tautomeric forms etc.

It is also possible to split an integral region into two parts if the automation has joint several peaks within one region. This may be done by clicking the “cut integral in two parts” button (). The bias and slope for selected integrals – or for all integrals, if no region is selected – may also be adjusted manually (). Slope and bias modify the baseline correction of the integration.

Comparing integrals from different spectra: The commands **li**, **lipp** and **lippf** (see above) evaluate the parameter **intscl** if the regions have been determined interactively. For **intscl** ≠ -1, the current dataset is defined as reference dataset for integral scaling. Then the value for **intscl** defines the number of the integral region that will be used as the reference for all the following spectra. For **intscl** = -1, the integrals of the current dataset are scaled relative to the reference dataset defined before. As such, you can compare the areas of peaks in a series of experiments.

2.5 Spectra interpretation

The 1D proton spectrum of a 50mM quinine solution in DMSO-d6 is shown in Figure 2.4. The spectrum has been acquired with the PROTON standard parameters. Figure 2.5 shows an expansion of the high field region of this spectrum.

Figure 2.4: 1D proton Spectrum of quinine in DMSO-d6.

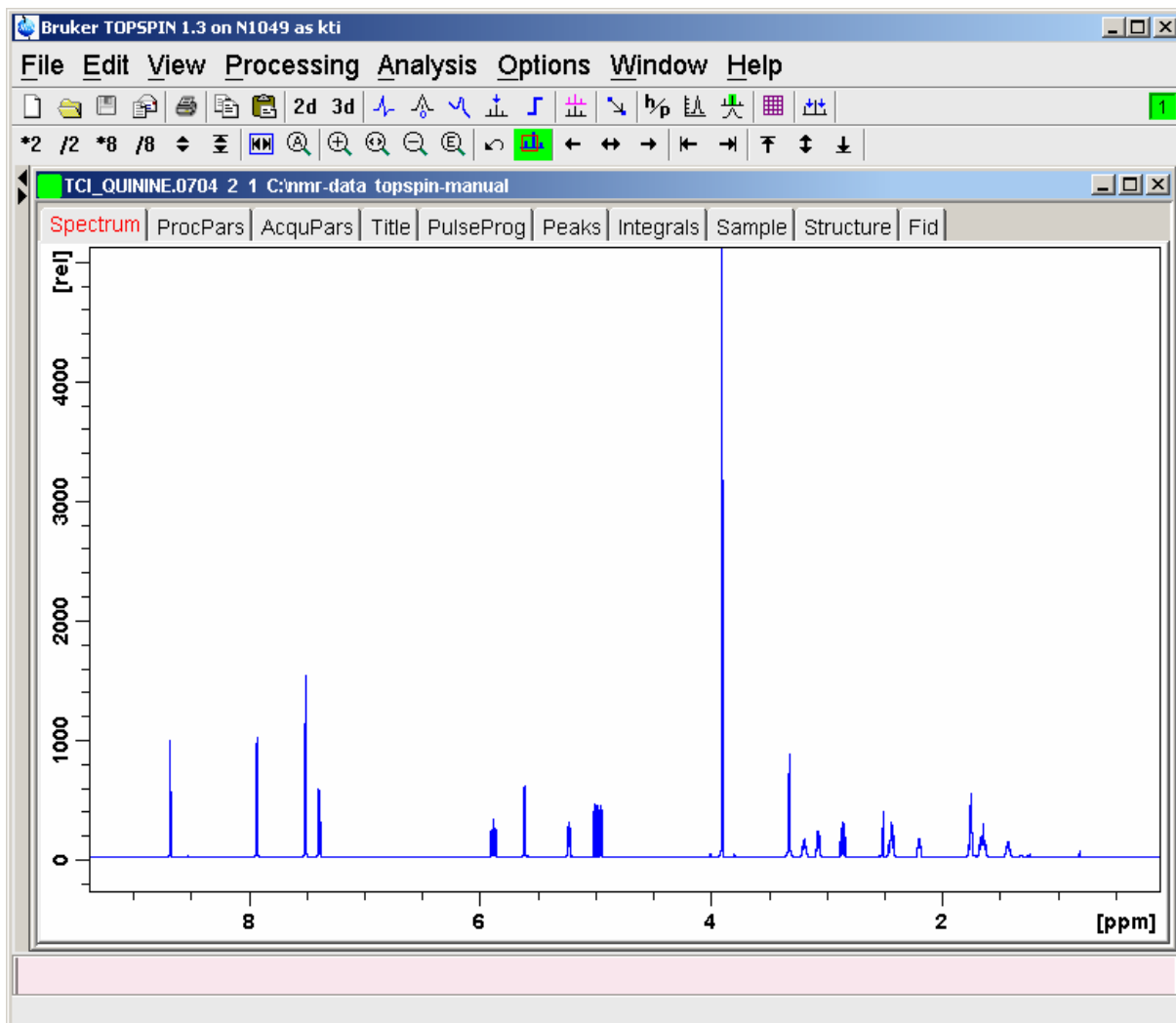
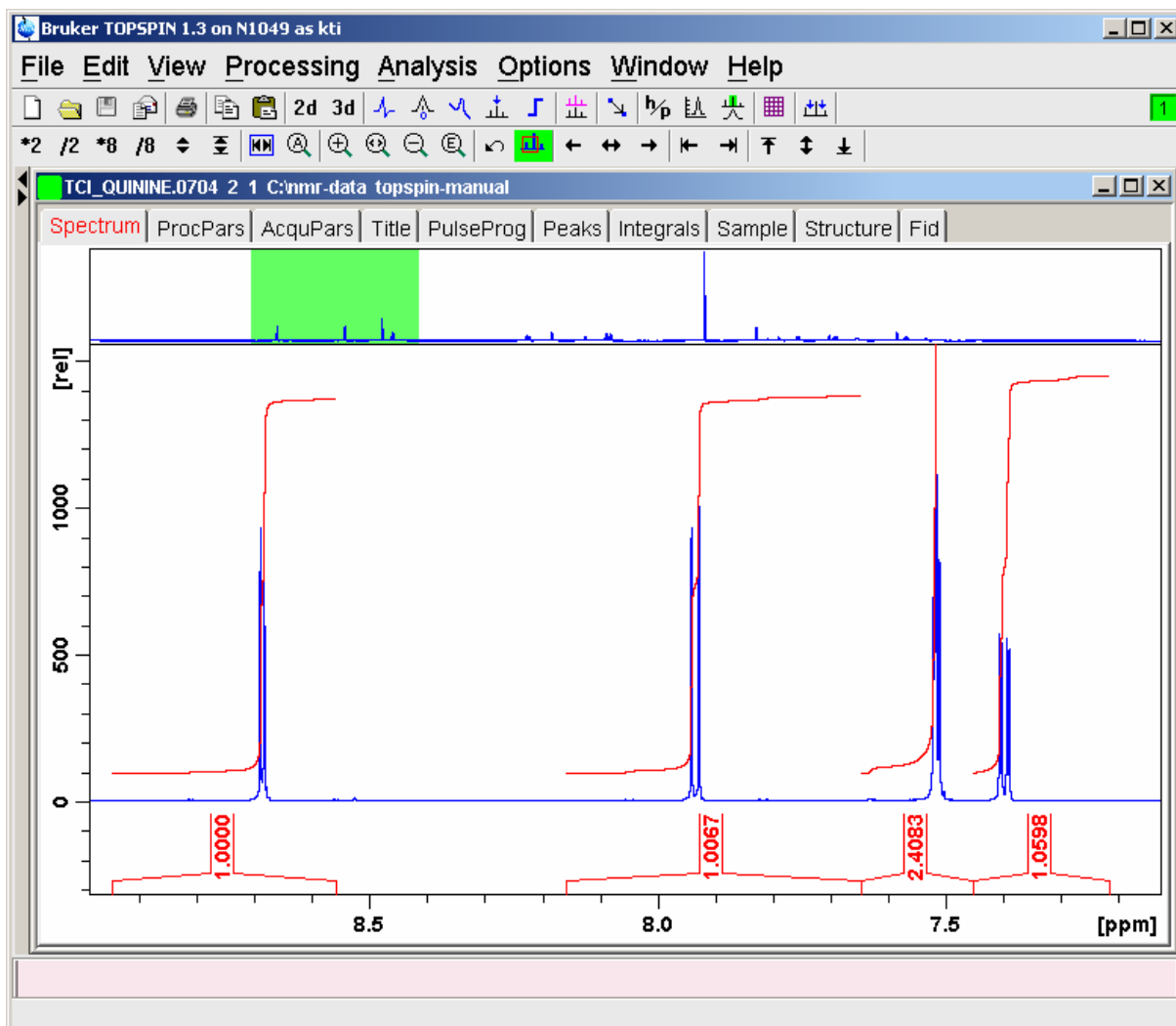


Figure 2.5: High field expansion of the above quinine spectrum.



Interpretation of 1D proton spectra generally involves the retrieval of the following information:

Functional groups in the Molecule: Chemical shift information yields general information on (functional) groups. Typical chemical shifts for certain groups may be looked up in chemical shift tables.

Equivalent H atoms: The integral values indicate the amount of H atoms within the integration region. So if only separate peaks or multiplets are integrated, one can assess the number of H atoms that give rise to this peak. This helps to identify CH, CH₂ and CH₃ groups or other equivalent H atoms.

Constitution and molecular structure: The coupling constants reveal the H atom connectivity through three bond vicinal couplings: H-C-C-H (³J_{HH}) which are typically in a range of about 2 to 15Hz for small organic compounds. Geminal – or ²J_{HH} coupling constants (H-C-H) may reveal information about the hybridization of the C atom: sp³ ≈ 12Hz, sp² ≈ 3Hz. In zig-zag- or “W” conformations, sometimes ⁴J_{HH} couplings (H-C-C-C-H) may be observed (1 – 3Hz). Coupling constants are given in Hz and they are independent of the magnetic field strength. They may be retrieved by measuring the distance between the peaks in a multiplet using the measurement mode (↵).

Equivalent coupling constants in two different multiplets indicate that the H atoms of these multiplets are coupled in one of the described fashions (most likely $^3J_{HH}$ coupling). The values for coupling constants of some typical conformations are also published in tables.

Often the peak-overlap does not allow the retrieval of all coupling constants and thus 2D COSY spectra are acquired to reveal vicinal connectivity. (See chapter 5).

CH multiplicity information: ^{13}C satellite peaks – that may be observed in proton spectra with very good signal to noise levels – can be used to determine the direct C-H coupling constants ($^1J_{CH}$). These values yield information about the hybridization of the C atoms: $sp^3 \approx 125\text{Hz}$, $sp^2 \approx 167\text{Hz}$ and $sp \approx 250\text{Hz}$. The CH one-bond coupling constants are measured from the center of gravity of the main ^{12}CH peak to either one of the satellite ^{13}CH peaks (which are smaller than the main peak by about a factor of 100).

The ^{13}C satellites are easily identified for separate peaks and multiplets but may not be revealed when peaks overlap. In this case, a coupled ^{13}C spectrum could in principle be acquired, which – in addition to the ^{13}C chemical shifts – yields the same information but with the much larger spectral dispersion (see chapter 3.5). However, this is very time consuming, and therefore the information about the multiplicity is either gathered from a sequence of DEPT spectra (see chapter 4) or from a multiplicity edited 2D-HSQC spectrum. Both of these also show the ^{13}C chemical shifts of the carbon atoms that have H atoms connected. But the edited HSQC spectrum also yields CH connectivity information and is faster than the 1D-DEPT series on inverse probes (BBI, TXI, TBI etc.). You may also get the multiplicity information from a series of 1D-APT spectra (chapter 4), which have the advantage over the DEPT spectra that also the chemical shifts of quaternary carbons and other carbons without H atoms will show up.

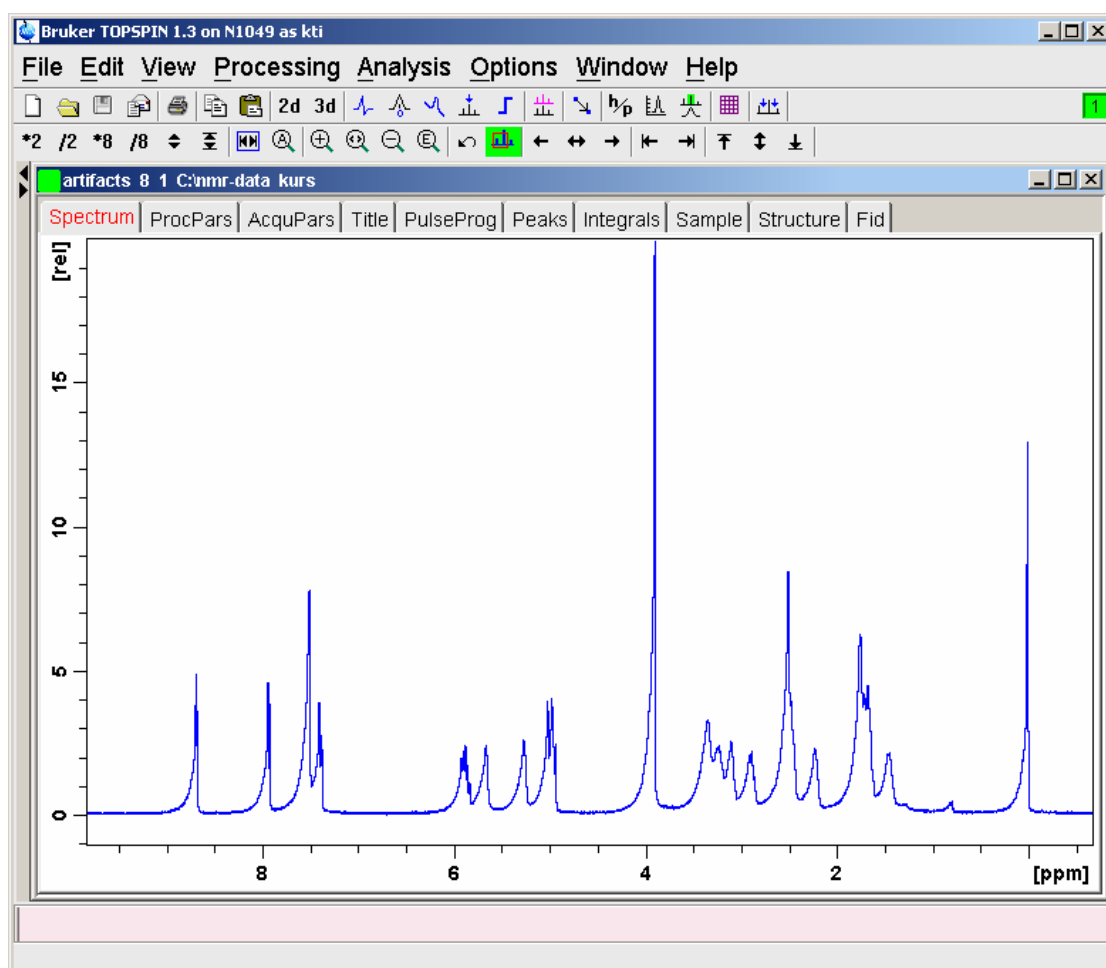
2.6 Possible pitfalls

Using the standard parameter set, which is called up by typing **rpar PROTON all** and **getprosol** (see the chapter on data acquisition), will lead to satisfactory spectra without the need to change parameters.

However some common pitfalls and artifacts that may lead to unsatisfactory results are described here. We describe the most commonly observed phenomena and the causes as well as solutions to these relatively common things.

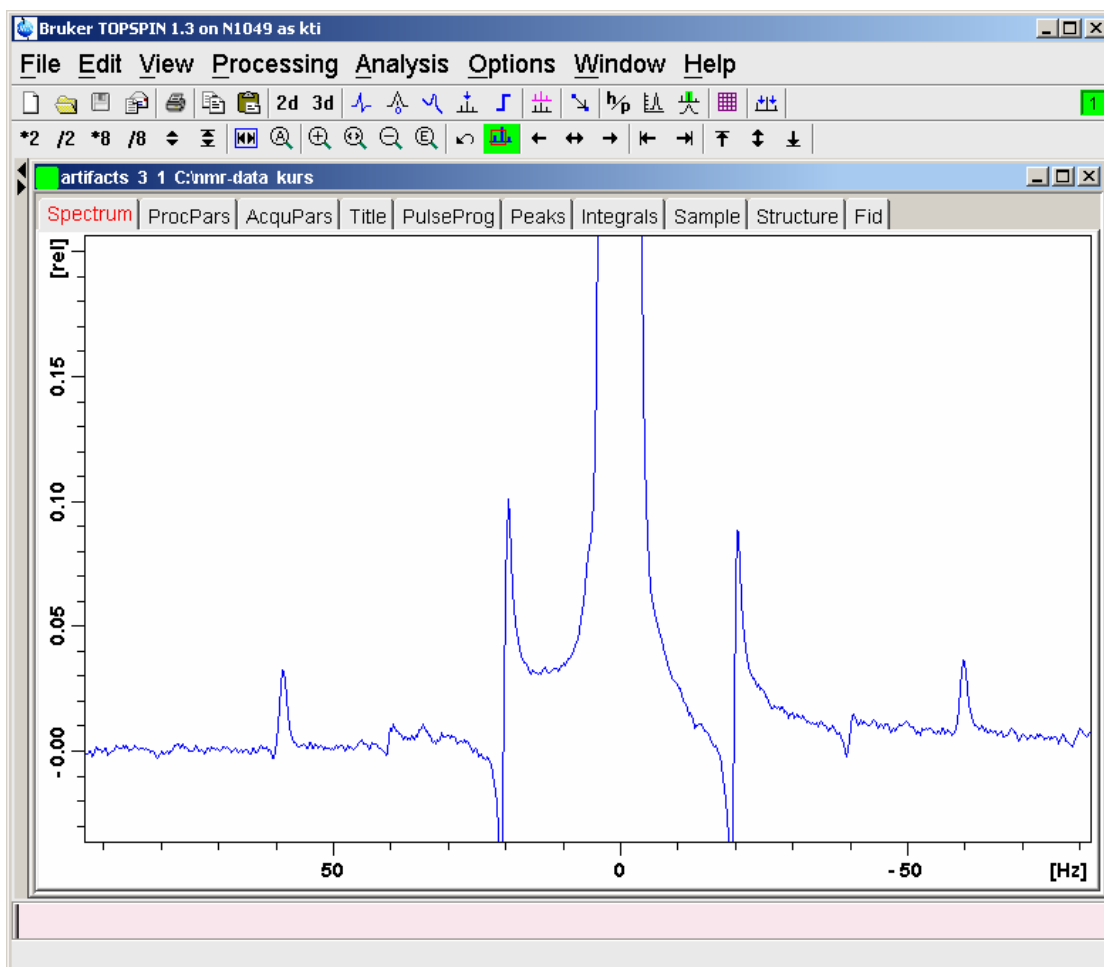
- Bad lineshape (see Figure 2.6): This is often due to bad shimming and that then results either in very broad peaks or peaks that tilt in one direction or both. The only way around it is to shim the sample either manually or using automatic shimming routines like **gradshim** or **tune** (see chapter 1.7). Nevertheless it may also be worth to check if the sample depth has been adjusted correctly. This is done by using the depth gauge and in most cases – at least for most 5mm probes – the sample depth should be 20mm. Hint: older depth gauges are adjustable and often the adjustment screw is mis-set, so make sure the tube bottom really is at 20mm.

Figure 2.6: 1D proton spectrum acquired with very bad magnetic field homogeneity (bad shim values for z and z2 shims).



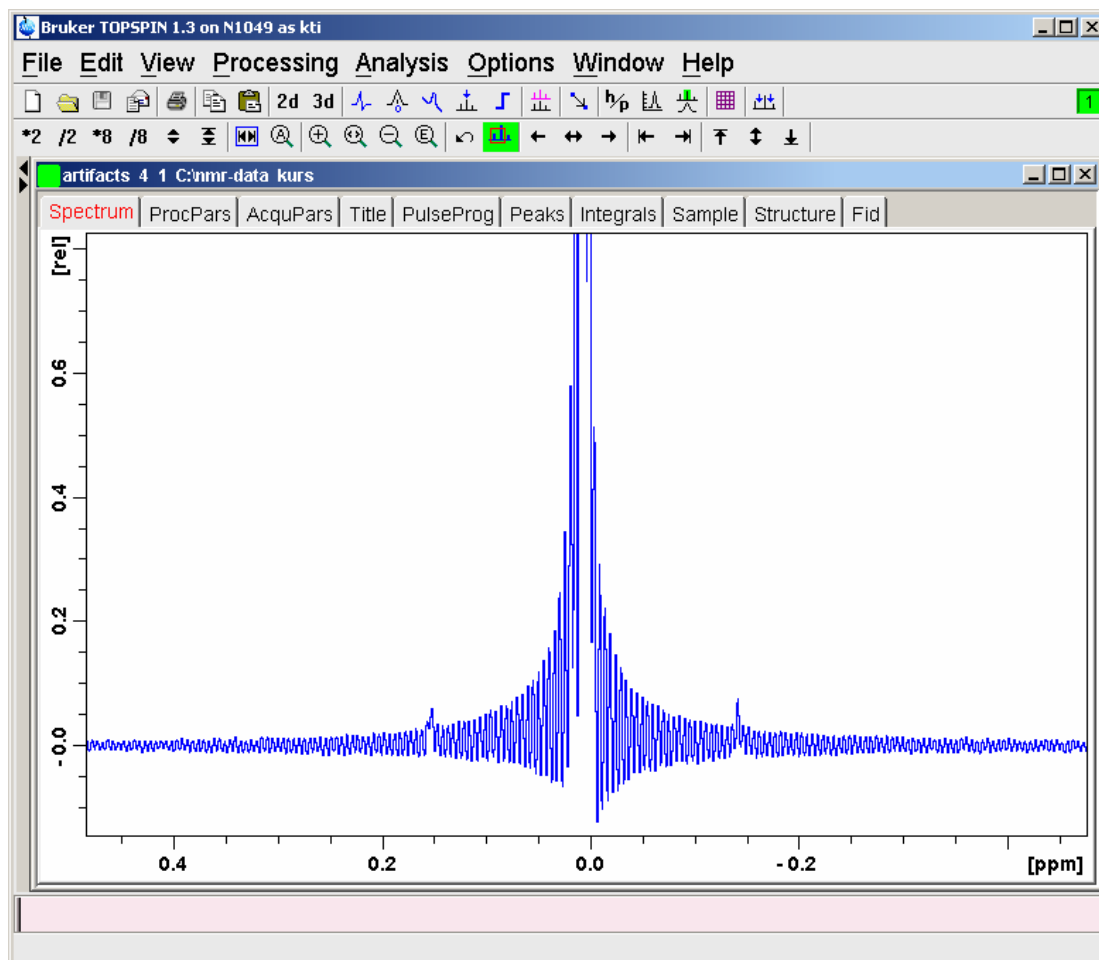
- Spinning sidebands (see Figure 2.7): These satellite peaks may occur if the sample is spun during the acquisition and a mediocre quality sample tube and/or spinner is used. The spinning sidebands are satellite peaks that appear on either side of each main peak in the spectrum and may reach intensities of a few % of the main peak. They can be identified easily, since they occur at the same distance for all peaks. The distance equals the spinning frequency and usually is 20Hz. Turn off the spinning or use high quality glass tubes and spinners. The spinning sidebands are large if the offaxis shims are far off the optimal values. In order to reduce spinning sidebands, you should not neglect the offaxis shims completely.

Figure 2.7: Spinning sidebands and several harmonics of 20Hz (spinning frequency).



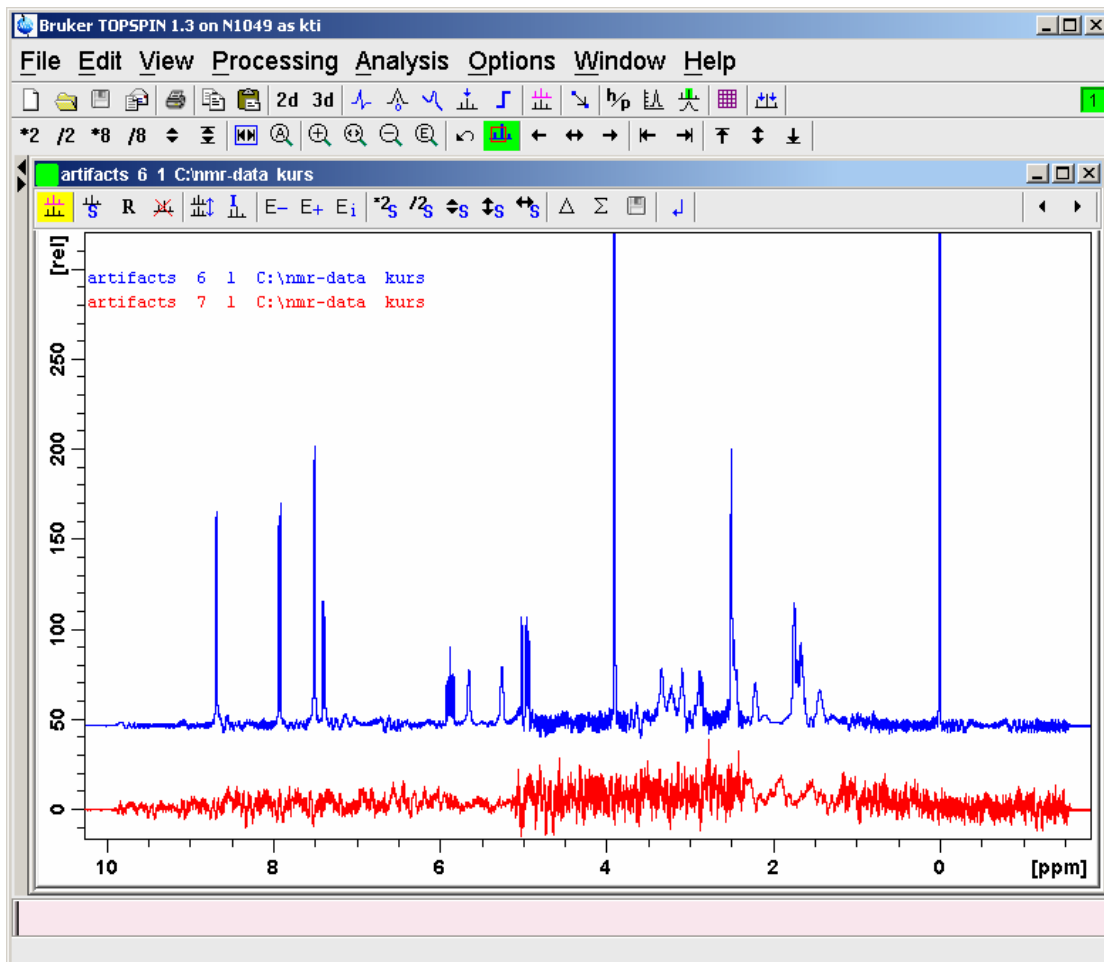
- Wiggles around the bottom of each peak (see Figure 2.8): These are truncation wiggles and indicate that either the receiver gain has not been adjusted or the acquisition time was too short. Check the FID of the spectrum and see if it has decayed to zero at the end. If not, increase **aq** or increase **td** (which also will increase the acquisition time **aq**). Also run **rga** before the acquisition in order to adjust the receiver gain and to avoid top truncation of the FID.

Figure 2.8: Spectrum with truncation wiggles: Acquisition time was too short or *rg* was too large.



- Dips below the baseline and unsymmetrical wiggles in each peak (see Figure 2.9): This indicates that the sample has not been locked properly. Execute the **lock** command to lock on the deuterated solvent.

Figure 2.9: 1D proton spectrum, partly unlocked (top) and fully unlocked (bottom). The lock sweep was turned on during acquisition. (If the lock sweep is turned off, spectra may be acquired in the unlocked mode. Referencing may become a problem and lines might get broad though.)



- Miscalibration of chemical shifts by up to 0.5ppm: This happens sometimes in the automation – either in IconNMR or using the **xaup** command – if no internal standard has been added. The reason is that the **sref** command finds a very small peak (possibly noise) close to 0ppm. It assumes that this is TMS and sets it to 0ppm. You may undo this by setting **sr** to 0Hz.

3 Basic ^{13}C Experiments

3.1 General information about the experiments

^{13}C detected 1D experiments are widely used in high resolution NMR, often when ^1H spectra are not sufficient for structural verification or elucidation. ^{13}C spectra yield a much larger spectral dispersion than proton spectra since the chemical shifts of the signals can be expected pretty much from 0 to 250ppm. The problem however is the sensitivity of the ^{13}C spectra which intrinsically is about 20 000 times less sensitive than a ^1H spectrum. This requires quite long experimental times for all ^{13}C detected spectra.

Also, often different probe types are used for direct observe ^{13}C spectroscopy. These so called “observe” probes (DUL, QNP, BBO and others) have the highest sensitivity on the carbon channel other than so called “inverse” probes (SEI, TXI, BBI, etc.) which focus on the ^1H channel. Often – especially when an inverse probe is installed – ^{13}C direct observe spectra are avoided if possible. Similar information may be gathered from a combination of HSQC and HMBC spectra (see chapters 9 and 11). Nevertheless, it is of course possible to run ^{13}C observe spectra also on inverse probes, the sensitivity will just be lower than on observe probes.

In all of the following experiments, all ^{13}C signals can be observed in principal (CH_3 , CH_2 , CH and quaternary C). However the quaternary carbon atoms often have quite long relaxation times. So, for practical recycle delays **d1** of 1 or 2 seconds, the intensities for the quaternary carbons may be substantially smaller than all other signals.

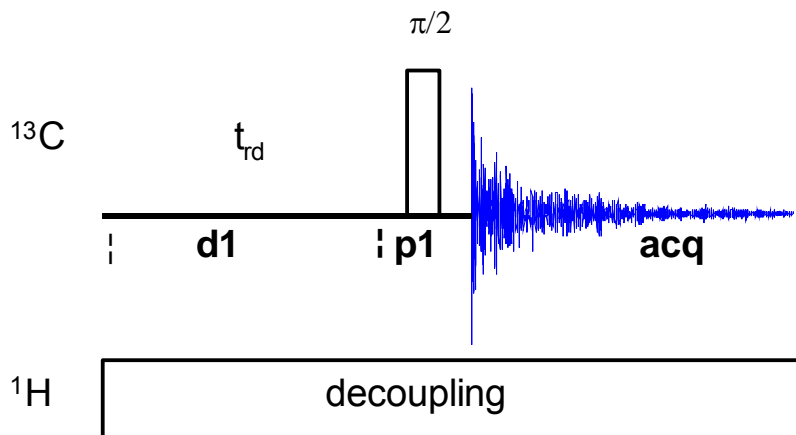
3.1.1 Pulse sequences and a few NMR details

Proton decoupled ^{13}C spectrum: The most frequently used experiment is the ^1H decoupled ^{13}C experiment. This experiment yields information on carbon chemical shifts only. The peak integral values can not be used due to possible NOE enhancement build-up during the decoupling. Also, all ^1H coupled multiples are collapsed into singlet peaks, which also enhances the signal to noise. This makes this experiment the most sensitive one of the basic ^{13}C experiments.

The parameter set for the ^{13}C experiment with a so called “power gated” ^1H decoupling is called C13CPD and the pulse program used is zgpg. The ^1H decoupling is executed during the recycle delay **d1** and during acquisition using a composite pulse decoupling (CPD) scheme defined by parameter **cpd2**. The CPD sequence which is used for the ^1H decoupling is the WALTZ-16 sequence. The decoupling power during the recycle delay is defined by the parameter **pl13**. It should be somewhat weaker than **pl12** – which is the decoupling power during acquisition. Usually **pl13** is set about 2 dB higher than **pl12** (larger power level values correspond to lower power). Nevertheless, the values for **pl12** and **pl13** should already be entered in the **edprosol** table by the NMR superuser and are called up in the experiment as usual by typing **getprosol**. A graphical representation for the pulse sequence is presented in Figure 3.1. An example for a spectrum is displayed in

Figure 3.4.

Figure 3.1: ^{13}C experiment with decoupling during *d1* and during acquisition.

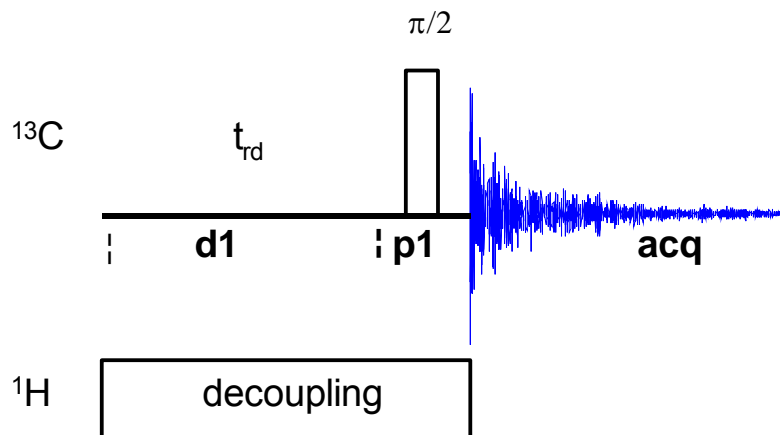


^1H coupled ^{13}C experiment with NOE enhancement. Using the “gated decoupling” experiment one likes to observe a ^1H coupled ^{13}C spectrum in order to determine J_{CH} coupling constants for example. But in order to still be able to profit from the signal enhancement due to NOE transfer, it is necessary to turn on decoupling during the recycle delay *d1*. Decoupling is turned off however during acquisition in order to acquire the coupled spectrum. Due to the NOE enhancement, the integral values of the peaks are not uniform and can not be used. This experiment yields somewhat smaller peaks than the decoupled spectrum, since the multiplets are not collapsed into one resonance frequency anymore.

The parameter set for this experiment is called C13GD and the pulse program used is zggd. ^1H decoupling is executed during the recycle delay *d1* and during acquisition using a composite pulse decoupling (CPD) scheme defined by parameter **cpd2**. The CPD sequence which is used for ^1H decoupling is the WALTZ-16 sequence. The decoupling power is defined by the parameter **p12**. The value for **p12** should be entered in the **edprosol** table by the NMR superuser and are called up in the experiment as usual by typing **getprosol**. A graphical representation for the pulse sequence is presented in Figure 3.2 and an example spectrum is given in

Figure 3.4.

Figure 3.2: Pulse sequence for gated decoupling.



¹H decoupled ¹³C experiment for integration: Sometimes, the integrals of the carbon signals become of interest e.g. to determine the number of equivalent carbon atoms in the molecule. In this case, the NOE enhancement – which may be quite different for different C atoms in one molecule – must be totally relaxed before acquisition. The NOE transfer takes place during decoupling and thus a very long recycle delay **d1** is needed between scans, where no decoupling is applied. Decoupling is applied however during acquisition to collapse the multiplets into singlets and thus gain signal to noise.

The parameter set for this “inverse gated” experiment is called C13IG and the pulse program used is zgig. ¹H decoupling is executed during acquisition only, using a composite pulse decoupling (CPD) scheme defined by parameter **cpd2**. The CPD sequence which is used for ¹H decoupling is the WALTZ-16 sequence. The decoupling power is defined by the parameter **p12**. The value for **p12** should be entered in the **edprosol** table by the NMR superuser and are called up in the experiment as usual by typing **getprosol**. The recycle delay **d1** has to be at about 30 - 60 seconds long in order to get rid of partial NOE enhancement and to obtain reliable integration information.

¹H coupled ¹³C experiment without NOE enhancement: This is the least sensitive experiment and therefore is nearly never used. No decoupling is applied at all and thus no NOE build-up falsifies the integration values. Also J_{CH} coupling is observed.

In order to setup this experiment, load the C13CPD parameter set and change the pulse program to zg. This is the same pulse program as for the 1D proton experiment but reading the C13CPD parameter set makes sure that pulses and acquisition takes place on the carbon channel. Also all other parameters are set from C13CPD (except pulse lengths and power levels of course, which are entered by the **getprosol** command).

3.2 Preparation and Acquisition

The steps that belong to the spectral acquisition are all arranged in the NMR spectra acquisition guide, which may be invoked from the **Acquisition → Data Acquisition Guide** menu.

3.2.1 Data acquisition step by step

- Make sure that the sample tube is properly adjusted in the spinner if needed and insert it into the magnet. (For more information on sample preparation and handling, please refer to chapter 1.4 on page 15).
- It is advised to acquire a ^1H 1D spectrum before this experiment, just to check the integrity of the sample itself.
- If needed, make a new dataset, type **edc** or **new** or select **File → New** from the menu.

Here, the dataset name, the experiment number (**EXPNO**), the processing number (**PROCNO**), the directory and the user name are entered. All of these entries will become directories on the respective hard-disk. (For more information on directory structures, refer to chapter 1.3.1).

You may also choose the correct solvent in the **Solvent** field and select a parameter-set here in the **Experiment** field. The experimental parameters for acquisition, processing, plotting and output will be loaded from the selected parameter-set as if you would have typed **rpar**. You may also give a title.

- If you have not selected a parameter-set yet (see above), type **rpar C13CPD all** for the fully decoupled spectrum, type **rpar C13GD all** to observe J_{CH} coupling or type **rpar C13IG all** in order to use peak integral information. This will select the standard parameters, which may be used as they are or which may be adjusted to your needs later.

If you intend to run a series of these experiments, you may also read only the first parameter set, modify the parameters of your choice and then copy the parameters into a new experiment number using the **ixpno** command. All you need to do then is to exchange the pulse program (**pulprog**, refer to the acquisition parameters in section 3.2.2 for details) and all the other parameters stay the same as in your first experiment.

- If you have not done so before, lock the sample by typing **lock** and select the correct solvent.
- Match and tune the sample either manually by typing **wobb** and physically adjusting the matching and tuning sliders or screws on the probe – if you do not have an ATM probe – or automatically by typing **atma** – if you do have an ATM probe.

The matching and tuning routine will first start on the ^{13}C channel and will then go to the ^1H channel. If you like to only match and tune the ^{13}C channel (e.g. because you have matched and tuned this sample on ^1H already for the previous ^1H experiment), you may type **atma f1**. At non-

ATMA probes, just type **stop** after you have tuned and matched the ^{13}C channel.

- If you would like to compensate for bad off-axis homogeneity but would not like to shim the off-axis shims, you may spin the sample. Press the spinning button on the BSMS keyboard or type **ro**.
- If not done so before on this sample, shim the sample either manually or by using the gradient shimming automation routine, type **gradshimau**.
- Type **getprosol** to load the probe dependent parameters!
- Adjust acquisition parameters or start the acquisition. We recommend that you use the automation mode by typing **xaua**. You may also start the receiver gain adjustment manually (type **rga**) and then start the acquisition and type **zg**.

If you intend to run a whole sequence of experiments consecutively, you may set them all up in consecutive experiment numbers as described. Then start them all by typing **multizg** in the first experiment number of the sequence.

3.2.2 Important acquisition parameters for this experiment

There are some acquisition parameters that may be modified for this experiment. The values of the parameters may be edited by clicking the AcquPars tag in the main window. You may access the full set of all acquisition parameters also by typing **eda** or a reduced set, where only parameters are displayed that are relevant for the selected pulse program by typing **ased**. Each parameter may also be accessed by typing its name in lower case letters.

Table 3.1: Acquisition parameters that may be adjusted from the default parameter-set

Parameter	Explanation	Comments and possible values
PULPROG	pulse program for the acquisition	<ul style="list-style-type: none"> • zpgp for the most sensitive, fully decoupled version without integration. • zggd for the coupled version and with NOE enhancement (no integration). • zgig (using long d1 values!) for the integration of decoupled spectra. • zg for the least sensitive experiment without decoupling at all
NS	number of scans	Typically 128 – 1k but the value may be increased if higher signal to noise is desired. More scans = longer experiment time.
DS	dummy scans	Typically 0 – 2
SW, TD, AQ	spectral width, time-domain, acquisition time	These parameters are inter-dependant. sw (in ppm, or correspondingly swH in Hz) defines the width of the spectral window and it has to be large enough to incorporate all peaks of the spectrum.

		Typically all ^{13}C peaks fall within 250ppm but it may be less. The td should be chosen in a way that the aq is about 3 seconds long.
O1P	transmitter frequency	The o1p (in ppm or o1 in Hz or sfo1 in MHz) defines the center of the spectral window (sw or swh). For ^{13}C , about 100ppm is a typical value for o1p .
O2P	decoupler frequency	o2p has to be set to the average of the ^1H resonance frequencies: ca. 5ppm
D1	recycling delay between two scans	Using 90° pulses, d1 + aq should be about $5 \cdot T_1$ in order to allow for complete relaxation before the next scan. For 30° pulses, shorter values may be used: typically 1 – 3 seconds.
RG	receiver gain	This is automatically adjusted using the commands xaua or rga .
P1, PL1	probe dependant pulse length and power level	These parameters are dependant on the individual probe and are loaded by the getprosol command.

3.3 Spectral processing

After the spectral acquisition has finished, the data has to be processed. You may do this either automatically using the **xaup** command or manually.

3.3.1 Automatic processing

The command **xaup** will invoke the automation AU program that is stored along with the processing parameters in the **aunmp** parameter. In this case the **aunmp** AU program is called **proc_1d**.

Typing **xaup** will automatically process the data and thus it will generate a phase corrected spectrum, it will also perform a baseline correction and it will do an automatic integration of the peaks. By default, a plot will be created using the plot-layout which is also stored in the processing parameters. For the C13CPD, C13GD, C13IG parameter-sets this layout file is called **1D_X.xwp**.

3.3.2 Manual processing

The acquired data may also be processed manually. The steps that belong to the spectral processing are all arranged in the NMR data processing guide, which may be invoked from the **Processing → Data Processing Guide** menu.

Window function: A window function may be applied to the FID for smoother spectra or to enhance either resolution or signal to noise. The command **em** applies an exponential multiplication to the FID where the related parameter **lb** (line broadening) defines the value of the exponential factor. The

command **gm** applies a gauss function multiplication which takes into account the two gauss factors **lb** and **gb**.


Exponential multiplication enhances signal to noise with the tradeoff of broader lines, while the gauss function enhances the resolution but decreases signal to noise.



For 1D ^{13}C spectra, usually an exponential multiplication is applied with **lb** = 1Hz.


Fourier transformation: After the application of the window function, the time domain data has to be Fourier transformed to yield a frequency domain spectrum. This is achieved with the command **ft**. Since exponential multiplication and Fourier transformation is often used consecutively, the command **ef** combines the **em** and the **ft** command.

Phase correction: The resulting spectrum will have to be phase corrected. There are two alternative mathematical algorithms for automatic phase correction procedures. They are executed by the commands **apk** and **apks**, respectively.

If – for some reason – only a part of the spectrum should be taken into account for phase correction, this may be done with the command **apkf**. The left and right limits of the region that shall be considered are defined by the processing parameters **absf1** and **absf2** respectively.

It is also possible to manually phase correct the spectrum. Click the phase correction button  or type **ph** and select **manual phasing** from the dialogue window. The position of the reference- or pivot point is indicated by a red vertical line. By default, the highest peak is defined as the pivot point but if this peak is close to the center of the spectrum, it is advised to select a peak somewhere near the edge of the spectrum as pivot point. Move the cursor over the peak, press the right mouse button and select **Set Pivot Point** from the context menu.

Use zero order phase correction to correct the phase around the area of the pivot point: place the cursor over the  button, hold down the left mouse button and move the mouse up or down. Thus, adjust the 0 order phase value until the peak at the pivot point is positive and the baseline around it is flat. Then adjust the first order phase value in the same way by holding down the left mouse button over the  button. Move the mouse up and down until the peak on the opposite side of the spectrum – with respect to the reference peak – is positive and the baseline around this peak is flat as well.


By clicking the save-and-return button () , the phase correction will be applied to the spectrum and the values for zero- and first order phase correction will be stored to the corresponding processing parameters: **phc0** and **phc1**. These parameters may now be used for phase correction of subsequent spectra by typing the command **pk**.

The command **efp** combines the commands **em**, **ft** and **pk**. Thus it applies an exponential multiplication to the FID (using the **lb** parameter). It then Fourier transforms the data and applies the phase correction values, stored as parameters **phc0** and **phc1**.

Calibration and referencing: The chemical shift ppm axis may be calibrated. The **sref** command automatically looks for a peak at around 0ppm (\pm

0.5ppm) and assumes that this is the TMS or another internal reference substance. It will then calibrate the axis of the spectrum in a way that this peak is at exactly 0ppm. If **sref** does not find a peak at around 0 ppm, it uses the solvent information for the axis calibration.

This method only works unambiguously if you have added TMS or another internal reference compound to your sample and if no peaks from your compound are in the area near 0ppm.

You may also use the manual mode to calibrate the spectrum. Zoom into the peak of interest, which you'd like to set to a certain ppm value (e.g. the residual protonated solvent peak). To zoom into a certain region of a spectrum, hold down the left mouse button in the spectrum display and drag the cursor over the area of interest. Then click on this button  to enter the manual calibration mode.



Place the red line of the cursor over the top of the peak that you'd like to use for calibration and click the left mouse button. Enter the desired frequency at the point of the cursor into the calibration window that opens up. (If you have selected the center peak of the DMSO-d5 multiplet for example, you'd enter 39.5ppm here). Click **OK** and you're taken back to the default display and the axis calibration is stored into the processing parameters as the **sr** parameter. This parameter is also adjusted by the **sref** command.


Baseline correction: The baseline of the spectrum may be corrected automatically by the command **abs**. This will then apply a polynomial baseline correction where the order of the polynomial function is defined by the processing parameter **absg**. The value for **absg** may range between 0 and 5. The default value for **absg** stored with the PROTON parameter set is 5.

absd uses an alternative mathematical algorithm than **abs**. It is, for example, used when a small peak lies on the foot of a large peak. In that case, **absd** allows you to correct the baseline around the small peak which can then be integrated. Usually **absd** is followed by **abs**.

Both of these baseline correction commands will also automatically integrate the peaks of the spectrum. To display the integrals determined by one of the above commands, right-click inside the data window and select "Display Properties", then check the entry "Integrals" and click OK. Note that integral values only make sense for the inverse gated ^{13}C experiment or the experiment without any decoupling!

Automatic baseline correction may also be applied only for parts of the spectrum. The processing parameters **absf1** and **absf2** define the left and the right limit of the spectral region (in ppm), where the baseline correction should be applied. Then use the command **absf** to correct only the selected region.

In order to enter the manual mode for baseline correction, click on the baseline button (). You may also type **bas** and select the option "correct baseline manually". Here you may select different mathematical functions for the baseline (polynomial-, sine- and exponential functions). The corresponding factors for the functions may be adjusted by keeping the appropriate button pressed () while moving the mouse. You may also select individual baseline points and apply a cubic spline correction. By

clicking on the difference button () , you may review the result before saving the changes.

3.3.3 Processing parameters

The processing parameters may be displayed by selecting the ProcPars tag in the TopSpin display window or by typing **edp**. Some of these processing parameters govern certain processing commands and may be optimized before the application of the respective processing command. Each parameter may also be accessed by typing it's name in lower case letters.

Table 3.2: Processing parameters that may be adjusted from the default parameter-set

Parameter	Explanation	Comments and possible values
SI	Size of the real spectrum	This corresponds to TD in the acquisition parameters. si defines the number of real data points that are used for the processing. If the value for si is larger than $\frac{1}{2}$ td , zero filling is applied since td is given in complex numbers. Zero filling smoothes spectra, so usually si = td . If si < $\frac{1}{2}$ td , then some of the acquired data points are not taken into account!
SR	Spectral reference	This parameter is altered by the spectral referencing. It is 0 if no axis referencing is performed.
LB	Line broadening $\exp(-\mathbf{lb} \cdot t)$	The lb governs the em and the gm command for the application of window functions. For em , the default value for lb is 0.3Hz. The larger lb , the broader the lines. For gm , lb has to be less than 0.
GB	Gaussian factor $\exp(-\mathbf{gb} \cdot t^2) \cdot \exp(-\mathbf{lb} \cdot t)$	The gb factor governs the gm window function together with lb . gb must be larger than 0 and smaller than 1.
PHC0 , PHC1	phase correction for 0 and 1 st order	These values are entered by the phase correction routines and are applied by the processing commands pk , fp , efp .
ABSG	order of the polynomial for abs	$0 \leq \mathbf{absg} \leq 5$. Usually absg = 5 works for most spectra.
ABSF1 , ABSF2	left and right limit for absf and apkf	If only parts of the spectrum shall be considered for baseline- or phase correction, these parameters define the limits.

3.4 Post-processing

After the spectra are processed (Fourier transformed, phase corrected, referenced and baseline corrected), peaks may be picked and integrated and the spectrum may be plotted for further interpretation.

3.4.1 Peak picking

Type **pp** in order to enter the peak picking dialog window. There are different options on how to perform peak picking. In order to display the picked peaks, right click in the spectrum display window and select “display properties” from the context menu and tick the box “Peak labels”.

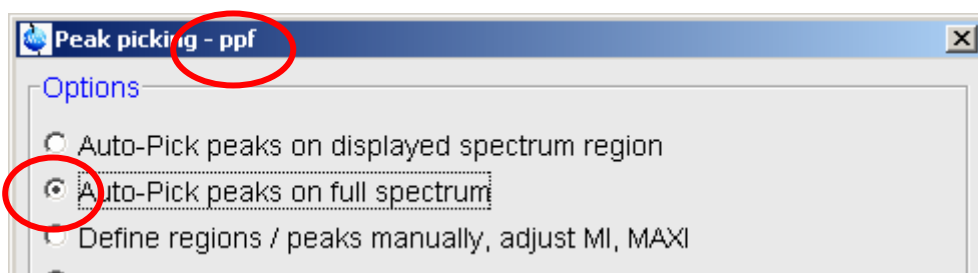
The picked peaks are stored in a peak list text file which may be displayed by selecting the “Peaks” tag in the main window. The peak list is interactive and you may correlate it with the spectrum and display spectrum and peak list at the same time. Right click in the peak list table and select “show spectrum” → “in correlated window” from the context menu. If you now move the mouse cursor over any entry in the list, the cursor in the spectrum will automatically jump to the corresponding peak in the spectrum. The peak list may also be exported as a text file or peak list file. Right click in the peak list window and select the “export” option from the context menu.


Automatic peak picking on the displayed region: Here the parameters **f1p** and **f2p** that define the left and right limit of the peak picking region are automatically set to the display region. One might have to adjust the values for **mi** and **maxi** however. **mi** defines the lower limit from where on peaks are considered as peaks and not as noise. The parameter **maxi** defines the upper limit where peaks that are larger than **maxi** are not considered anymore. If **mi** is too small, the peak picking routine will pick too many peaks in the noise floor. If **maxi** is smaller than the relative intensity of some peaks, these peaks will not be picked.


The automatic peak picking routine, which picks peaks in the full spectrum and which considers the parameters **mi** and **maxi** may also be executed without the graphical interface by typing **ppf**. If also the region – defined by **f1p** and **f2p** – should be considered, the command **pps** applies.


All possible command line commands for each of the options in the **pp** dialog box are displayed in the top frame of this dialog box.


Figure 3.3: peak picking dialog box and command line commands







Defining several regions for the automatic peak picking: You may enter the manual peak picking mode from the dialog box which is invoked by the **pp** command. Select “Define regions / peaks manually, adjust MI, MAXI”. You may also click on the peak picking button () in the main window in order to enter the manual mode for peak picking and region definition.

In the Manual peak picking mode you may define several regions to be considered for automatic peak picking. These regions can be defined by selecting the “define new peak picking range” button () . Then drag the

mouse cursor over the region that you'd like to select. Every peak that is in the box will be considered for automatic peak picking which is started after you are finished defining all regions by clicking the "pick peaks on the defined region" button (). The peaks have to be within the box. Peaks that are larger than the box will not be considered as well as peaks that end below the lower limit of the box.

Save the peaks into a peak list and leave the peak picking mode by clicking the "return, save changes" button (.

Manual peak picking: The manual peak picking mode is called up as described above (). With the "define peak manually" button (, you may left click on the position in the spectrum that you'd like to consider as a peak. To selectively delete picked peaks, right click at a marked peak. The semiautomatic peak picking () uses the automatic peak picking routine but lets you decide on each peak that it found. Clicking the left mouse button will search peaks on the right side of the cursor. Clicking the right mouse button will let you decide if you'd like to mark the spot that the routine has found as a peak or not.

All picked peaks are deleted by left clicking on the "delete all peaks" button (.



3.4.2 Integration

The integrals of a ^{13}C spectrum with inverse gated ^1H decoupling (C13IG) yield valuable information on the number of equivalent C atoms per peak. It has to be stated though, that the spectrum has to be acquired with a long enough recycle delay **d1** in order to accumulate the signals of fully relaxed ^{13}C atoms. The other important reason for long **d1** times is to make sure that the NOE enhancement – which is built up during the decoupling during the acquisition – is fully decayed. Only then, the integration values will make sense. Using the zgig pulse program with 90° pulses, **aq** + **d1** should be about $5 \cdot T_1(^{13}\text{C})$, where T_1 is the spin-lattice relaxation time of ^{13}C . For typical small, organic molecules T_1 values vary between a few hundred milliseconds and several seconds (especially quaternary carbon atoms have long T_1 times). The zgig30 pulse program which uses 30° pulses can be used with shorter **d1** values. Nevertheless, a good estimation is to use **d1** values of 30 – 60 seconds.

Display and integral lists: The integrals, along with their labels, may be displayed on the spectrum by clicking the right mouse button in the spectrum window and selecting "display properties" from the context menu. Here you'd have to tick the boxes "integrals" and "integral labels". The "integral labels" actually represent the integral value. They are also stored in an interactive integral table that can be accessed by selecting the "Integrals" tag. If peak picking has been performed before, the integral regions are split up in peaks. Moving the mouse cursor over an integral region or peak will move the cursor position to this integral or peak in the correlated spectrum. Right click in the integral table and select "show spectrum" → "in correlated window" from the context menu. The integral list may also be exported as a comma separated text file. Right click in the integral list window and select the "export" option from the context menu.



The commands **li**, **lipp** and **lippf** also generate and display integral lists as text files. The text files are stored in the datasets as “integrals.txt”, “integrals_lipp.txt” or “integrals_lippf.txt” respectively in the current processing number directory. The **li*** commands display the absolute integral values and regions (**li**), the absolute values and regions along with the corresponding peaks within the integral regions (**lipp**) or the same as **lipp** but for the full spectrum (**lippf**).

Automatic integral region definition and integration: Each spectrum is integrated automatically along with the automatic baseline correction using the command **abs** or **absd**. Integrals may be displayed in the spectrum as described above.

Manual integration and calibration: Often the automatic integration works well but one likes to break down integral regions in a more narrow way or one likes to simply calibrate integrals. This may be done in the manual integration mode which may be accessed by typing **int** and selecting “define integral regions manually” from the dialog window. It may also be accessed by clicking on the “interactive integration” button (). Here, new integral regions may be defined or selected, deleted, calibrated or normalized. Click on the “define new regions” button () and define regions interactively by dragging the mouse cursor over the desired region. Right click for a context menu, where you may select, delete, calibrate or normalize the integral in the region.

Calibration is used to define the multiplicity of the peaks. You may select a peak which you have identified as a CH group for example and calibrate it's integral to 1. All the other integrals within the spectrum will then be referenced to this one. They will have relative intensities according to the number of protons they represent (3 for the three equivalent protons in a CH₃ group for example and so on).

Normalizing will assign a value for the total sum of integrals over all integral regions (e.g. 100%). If you select “normalize” from the context menu, the portion of each region of this sum is displayed (e.g. 23.665 %). This may be very useful to assess the ratio of impurities in the sample or the ratio of tautomeric forms etc.

It is also possible to split an integral region into two parts if the automation has joint several peaks within one region. This may be done by clicking the “cut integral in two parts” button (). The bias and slope for selected integrals – or for all integrals, if no region is selected – may also be adjusted manually (). Slope and bias modify the baseline correction of the integration.


Comparing integrals from different spectra: The commands **li**, **lipp** and **lippf** (see above) evaluate the parameter **intscl** if the regions have been determined interactively. For **intscl** \neq -1, the current dataset is defined as reference dataset for integral scaling. Then the value for **intscl** defines the number of the integral region that will be used as the reference for all the following spectra. For **intscl** = -1, the integrals of the current dataset are scaled relative to the reference dataset defined before. As such, you can compare the areas of peaks in a series of experiments.

3.5 Spectra interpretation

Functional groups in the Molecule: Chemical shift information yields general information on (functional) groups. This is the only information in a normal C13CPD experiment but there is more and better information content in this than in the ^1H chemical shifts of 1D ^1H spectra. The chemical shift dispersion in ^{13}C spectra is a lot larger than in 1D ^1H spectra and much less peak overlap is observed which makes interpretation simpler. The only drawback is that the ^{13}C experiments are about 20 000 times less sensitive than ^1H experiments (for ^{13}C in natural abundance). Since the most sensitive ^{13}C direct experiment is the C13CPD, this is usually the only ^{13}C experiment run on a molecule. And here, only the chemical shift information can be used (no integrals, no coupling constants).

Typical chemical shifts for certain groups may be looked up in ^{13}C chemical shift tables.

Equivalent C atoms: Integration of ^{13}C peaks is often only the last resort since the necessary inverse gated decoupling experiment is extremely time consuming due to the long **d1** times that are required. Nevertheless, the integral values indicate the amount of equivalent C atoms within one peak. So – like in the 1D ^1H experiment – one can assess the number of C atoms that give rise to this peak by integral values.

C atom hybridization: In the ^1H coupled ^{13}C spectra (gated decoupling (zgpd) and spectra without any decoupling at all (zg)), the $^1\text{J}_{\text{CH}}$ coupling constants reveal information on the hybridization of the C atoms in the molecule. These coupling constants may also be observed as ^{13}C satellites in the 1D ^1H spectra but since in ^1H spectra there usually is large peak overlap, they may be obscured. $^1\text{J}_{\text{CH}}$ coupling constants for different hybridization states are: $\text{sp}^3 \approx 125\text{Hz}$, $\text{sp}^2 \approx 167\text{Hz}$ and $\text{sp} \approx 250\text{Hz}$. They are measured as the distance between the peaks in the multiplet using the measurement mode () \downarrow).

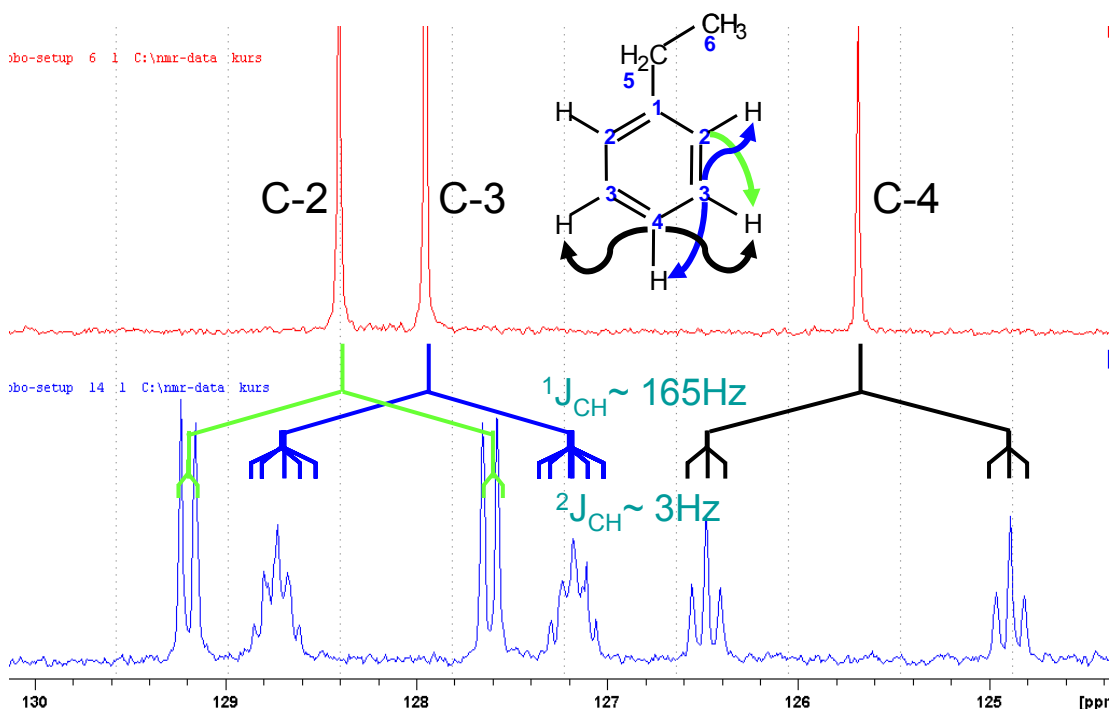
Next to the $^1\text{J}_{\text{CH}}$ coupling constants, one may also observe $^2\text{J}_{\text{CH}}$ coupling, which splits up the $^1\text{J}_{\text{CH}}$ coupled peaks in addition. $^2\text{J}_{\text{CH}}$ coupling constants are usually small and they are in the range of 2 to 15 Hz.

For an example of a coupled- and a decoupled spectrum see

Figure 3.4.

However, the ^1H coupled spectra are very time consuming and yield less signal to noise information than the ^{13}C CPD spectra. Therefore the information about the CH multiplicity is either gathered from a sequence of DEPT spectra (see chapter 4) or from a multiplicity edited 2D-HSQC spectrum. Both of these also show the ^{13}C chemical shifts of the carbon atoms that have H atoms connected. But the edited HSQC spectrum also yields CH connectivity information and is faster than the 1D-DEPT series on inverse probes (BBI, TXI, TBI etc.). You may also get the multiplicity information from a series of 1D-APT spectra (chapter 4), which have the advantage over the DEPT spectra that also the chemical shifts of quaternary carbons and other carbons without H atoms will show up.

Figure 3.4: ^1H - decoupled- and ^1H - coupled ^{13}C spectra of ethyl benzene. In the decoupled spectrum, $^1J_{\text{CH}}$ and $^2J_{\text{CH}}$ couplings are visible.



3.6 Possible pitfalls

Using the standard parameter sets, which are called up by typing **rpar C13CPD all**, **rpar C13GD all** or **C13IG all** and **getprosol** (see the chapter on data acquisition), will lead to satisfactory spectra without the need to change parameters.

However some common pitfalls and artifacts that may lead to unsatisfactory results are described here. We describe the most commonly observed phenomena and the causes as well as solutions to these relatively common things.

- Most likely, unsatisfactory results will occur due to too little signal. In order to get a feeling for the ^{13}C sensitivity of your probe, we suggest setting up the first experiments with very many scans. Start the experiment and check back from time to time if the signal to noise is satisfactory: type **tr** to transfer the data to the disk and process the data as described above.
- A baseline which is tilted in one direction or is quite wiggly indicates a too low **de** value. This may occur when you try to acquire a ^{13}C direct observe spectrum with an inverse type probe (BBI, TXI, SEI or others). You may just set the **de** to larger values (try to set **de** to about 12 to 20us).
- Miscalibration of chemical shifts by up to 0.5ppm: This happens sometimes in the automation – either in IconNMR or using the **xaup** command – if no internal standard has been added. The reason is that the **sref** command finds a very small peak (possibly noise) close to 0ppm.

It assumes that this is TMS and sets it to 0ppm. You may undo this by setting **sr** to 0Hz.

4 ^{13}C Experiments to Assess Multiplicities: DEPT and APT

4.1 General information about the experiments

The DEPT experiments as well as APT type experiments yield information about the proton multiplicity of the carbon atoms (C, CH, CH₂ and CH₃ may be distinguished). The distinctive feature in the spectra always is the sign of the phase of the peak. In these spectra peaks may be positive and/or negative.

The DEPT type spectra come in three variations: DEPT-45, DEPT-90 and DEPT-135. The DEPT-45 spectrum shows positive peaks for CH, CH₂ and CH₃. DEPT-90 will only show signals for CH and DEPT-135 shows positive peaks for CH and CH₃ groups and negative peaks for CH₂ groups. None of the DEPT type spectra will show peaks for quaternary carbons!

One version of the APT experiment will either show C and CH₂ groups as positive peaks and CH and CH₃ groups as negative peaks. The other version will only show quaternary carbons.

Usually a combination of DEPT and normal C13CPD spectra or APT and normal C13CPD spectra are used for structure elucidation. One of the most commonly used and most efficient combinations is to run a C13CPD which is followed by a DEPT-135 and – if necessary – also by a DEPT-90. In this way the quaternary carbons can be identified unambiguously by comparison of the DEPT-135 with the C13CPD. CH and CH₃ may be distinguished by comparing the DEPT-90 with the DEPT-135.

The DEPT sequence is about 4 times as sensitive as a normal C13CPD sequence.

The so called “observe” probes (DUL, QNP, BBO and others) are ideal to be used for ^{13}C direct observe spectra such as DEPT and APT type experiments. They have the highest sensitivity on the carbon channel other than so called “inverse” probes (SEI, TXI, BBI, etc.) which focus on the ^1H channel.

Often – especially when an inverse probe is installed – ^{13}C direct observe spectra are avoided if possible. Similar information may be gathered from a combination of edited HSQC spectra which also distinguish CH₂ groups from CH₃ and CH groups. These inverse detected 2D experiments have a much higher sensitivity than the ^{13}C observe experiments (especially on inverse probes). Nevertheless, it is of course possible to run ^{13}C observe spectra also on inverse probes, the sensitivity will just be lower than on observe probes.

4.1.1 Pulse sequences and a few NMR details

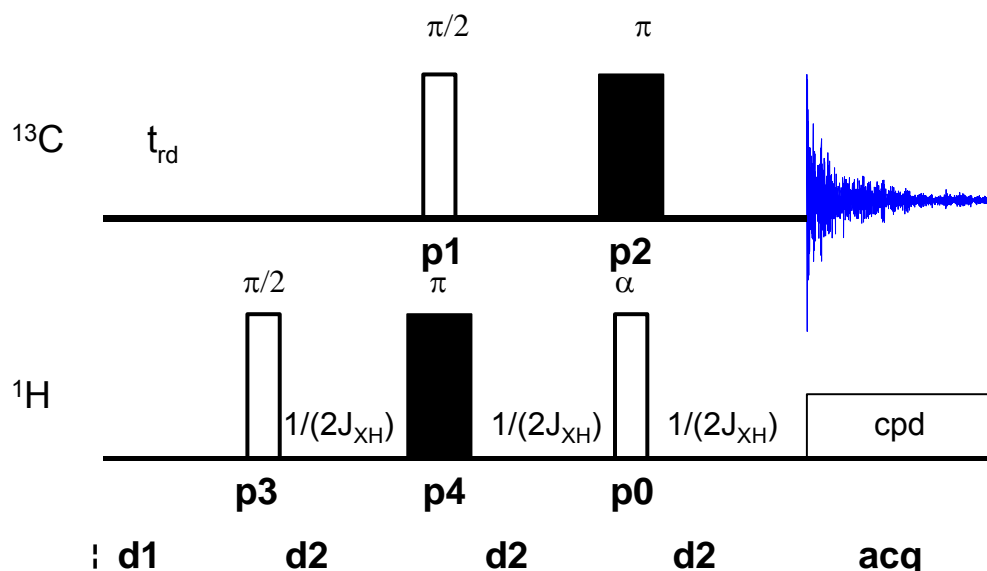
The DEPT type experiments: DEPT (Distortionless Enhancement by Polarization Transfer) is a polarization transfer technique used for the

observation of nuclei with a small gyromagnetic ratio, which are J-coupled to ^1H (most commonly ^{13}C). DEPT is a spectral editing sequence, that is, it can be used to generate separate ^{13}C subspectra for methyl (CH_3), methylene (CH_2), and methine (CH) signals. DEPT makes use of the generation and manipulation of multiple quantum coherences to differentiate between the different types of ^{13}C signals. Quaternary carbons are missing from DEPT spectra because the large one-bond heteronuclear J-coupling (J_{XH}) is used for polarization transfer. This coupling constant (in Hz) is represented as **cnst2** in the parameters. That means that only an average value can be used and depending on the real coupling constants in the molecule, this may not be ideal.

DEPT may be run with or without ^1H -decoupling and it is relatively insensitive to the precise matching of delays with coupling constants, and so is much easier to use than the closely related INEPT sequence. DEPT, on the other hand, is more sensitive to pulse imperfections than INEPT.

The DEPT pulse sequence is shown in Figure 4.1. The final ^1H pulse with flip angle α selects for the CH_3 , CH_2 or CH signals. This angle is set to 45° in the DEPT-45 sequence, which yields spectra with positive CH , CH_2 , and CH_3 signals; to 90° in DEPT-90, which yields spectra with only CH signals; and to 135° in DEPT-135, which yields spectra with positive CH and CH_3 signals and negative CH_2 signals.

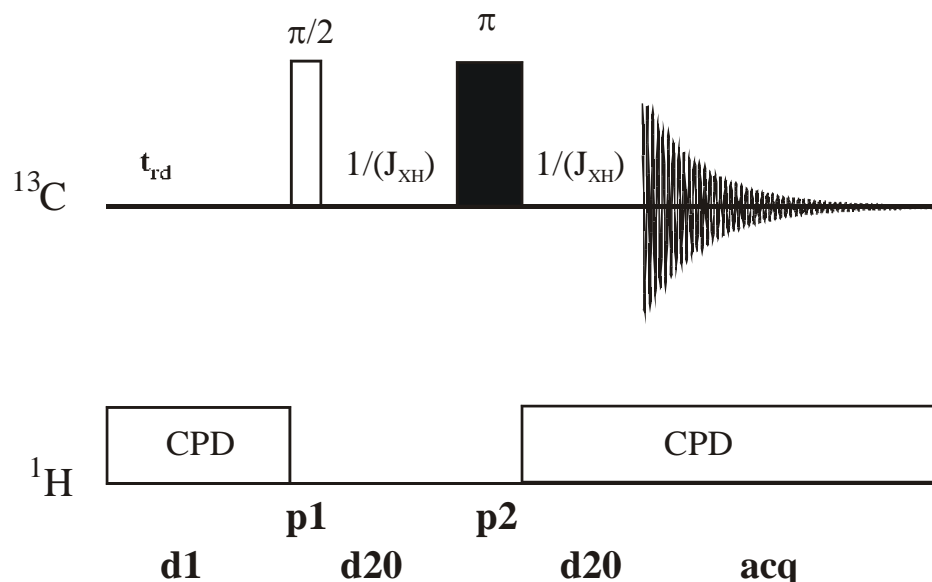
Figure 4.1: Pulse sequence for the DEPT type experiments.



The APT type experiments: The APT (Attached Proton Test) is a simple experiment for assigning multiplicities in ^{13}C NMR spectroscopy. The APT pulse sequence is shown in Figure 4.2. The first 90° pulse creates transverse magnetisation followed by a 180° pulse in the middle of the evolution period (spin echo sequence). During the evolution period the different components of the carbon multiplets precess at their individual frequencies. During the half of the evolution period the decoupler is OFF to introduce J-modulation in the spectrum. The length of the evolution period

controls the amplitude of the carbon signal. Normally the evolution period is set to $1/(J_{CH})$ then the CH and CH₃ groups appear as positive peaks while those from CH₂ and quaternary carbons are negative. Compared to the DEPT experiment all carbon nuclei are visible in one spectrum. Also here, the average value for the $^1J_{CH}$ coupling constant is represented by the parameter **cnst2** in the parameter-set.

Figure 4.2: The APT pulse sequence.



4.2 Preparation and Acquisition

The steps that belong to the spectral acquisition are all arranged in the NMR spectra acquisition guide, which may be invoked from the **Acquisition** → **Data Acquisition Guide** menu.

There are predefined parameter-sets for the DEPT type experiments. They are called C13DEPT45, C13DEPT90, C13DEPT135 and C13DEPT135p. The C13DEPT135p dataset uses the same phase values as the previous ^{13}C experiment. Thus it really yields spectra where the CH and CH₃ peaks are positive and CH₂ peaks are negative and not the other way around, if the previous experiment was phase corrected.

There is also a predefined parameter-set for the APT experiment: C13APT. This will automatically yield spectra where CH and CH₃ peaks can be phased in one direction while CH₂ and C peaks are opposite to this. If you like to run the experiment, that only shows quaternary carbon atoms, you'd have to set **cnst11** to 2.

4.2.1 Data acquisition step by step

- Make sure that the sample tube is properly adjusted in the spinner if needed and insert it into the magnet. (For more information on sample preparation and handling, please refer to chapter 1.4 on page 15).

- It is advised to acquire a 1H 1D spectrum before this experiment, just to check the integrity of the sample itself.
- If needed, make a new dataset, type **edc** or **new** or select **File → New** from the menu (see Figure 2.2 on page 28).

Here, the dataset name, the experiment number (**EXPNO**), the processing number (**PROCNO**), the directory and the user name are entered. All of these entries will become directories on the respective hard-disk. (For more information on directory structures, refer to chapter 1.3.1).

You may also choose the correct solvent in the **Solvent** field and select a parameter-set here in the **Experiment** field. The experimental parameters for acquisition, processing, plotting and output will be loaded from the selected parameter-set as if you would have typed **rpar**. You may also give a title.

- If you have not selected a parameter-set yet (see above), type **rpar C13DEPT45 all**, **rpar C13DEPT90 all** or **rpar C13DEPT135 all** for the DEPT-type experiments or type **rpar C13APT all** to setup the APT type experiments. This will select the standard parameters, which may be used as they are or which may be adjusted to your needs later.

If you intend to run a series of either group of these experiments, you may also read one of these parameter-sets, modify parameters and copy them into the next experiment number using the **ixpno** command. Then you may just exchange the **pulprog** for **dept45**, **dept90** or **dept135** and keep all the other changes (like **o1p**, **sw**, **cnst2** and others).

This approach has the advantage that you may use the same phase correction values for the processing of all spectra.

For the APT series, you do not exchange the pulse sequence but you will have to run one experiment with **cnst11 = 1** and one experiment with **cnst11 = 2**.

- If you have not done so before, lock the sample by typing **lock** and select the correct solvent.
- Match and tune the sample either manually by typing **wobb** and physically adjusting the matching and tuning sliders or screws on the probe – if you do not have an ATM probe – or automatically by typing **atma** – if you do have an ATM probe.

The matching and tuning routine will first start on the ¹³C channel and will then go to the ¹H channel. If you like to only match and tune the ¹³C channel (e.g. because you have matched and tuned this sample on ¹H already for the previous ¹H experiment), you may type **atma f1**. At non-ATMA probes, just type **stop** after you have tuned and matched the ¹³C channel.

- If you would like to compensate for bad off-axis homogeneity but would not like to shim the off-axis shims, you may spin the sample. Press the spinning button on the BSMS keyboard or type **ro**.
- If not done so before on this sample, shim the sample either manually or by using the gradient shimming automation routine, type **gradshimau**.

- Type **getprosol** to load the probe dependent parameters!
- Adjust acquisition parameters or start the acquisition. We recommend that you use the automation mode by typing **xaua**. You may also start the receiver gain adjustment manually (type **rga**) and then start the acquisition and type **zg**.

If you intend to run a whole sequence of experiments consecutively, you may set them all up in consecutive experiment numbers as described. Then start them all by typing **multizg** in the first experiment number of the sequence.

4.2.2 Important acquisition parameters for these experiments

There are some acquisition parameters that may be modified for this experiment. The values of the parameters may be edited by clicking the AcqPars tag in the main window. You may access the full set of all acquisition parameters also by typing **eda** or a reduced set, where only parameters are displayed that are relevant for the selected pulse program by typing **ased**. Each parameter may also be accessed by typing its name in lower case letters.

Table 4.1: Acquisition parameters that may be adjusted from the default parameter-set

Parameter	Explanation	Comments and possible values
PULPROG	pulse program for the acquisition	<ul style="list-style-type: none"> • dept45 for spectra showing peaks for CH, CH₂ and CH₃ groups all in the same phase. • dept90 for spectra showing only peaks for CH groups. • dept135 for spectra showing peaks for CH and CH₃ in one phase and CH₂ in the opposite phase. • jmod for the APT type spectra showing either CH and CH₃ in one phase and CH₂ and C opposite (cnst11 = 1) or C only (cnst11 = 2).
NS	number of scans	Typically 128 – 1k but the value may be increased if higher signal to noise is desired. More scans = longer experiment time. DEPT is more sensitive than C13CPD and APT.
DS	dummy scans	Typically 0 – 2
SW, TD, AQ, O1P	spectral width, time-domain, acquisition time, center of the spectrum	sw , td and aq are inter-dependant. sw (in ppm, or correspondingly swh in Hz) defines the width of the spectral window and it has to be large enough to incorporate all peaks. o1p defines the center of the spectrum in ppm. DEPT does not show high field quaternary C's therefore a smaller sw and o1p may be used (sw = 160ppm and

		o1p = 75ppm). For APT the whole range is necessary: sw = 250 and o1p = 110ppm. td should be chosen in a way that the aq is about 3 seconds long.
O2P	decoupler frequency	o2p has to be set to the average of the ¹ H resonance frequencies: ca. 5ppm
D1	recycling delay between two scans	Using 90° pulses, d1 + aq should be about 5*T ₁ in order to allow for complete relaxation before the next scan. For 30° pulses, shorter values may be used: typically 1 – 3 seconds.
CNST2	¹ J _{CH} coupling constant	cnst2 (in Hz) should be set to an average value for the ¹ J _{CH} coupling constants. Usually 145Hz is a good approximation.
CNST11	in APT only	cnst11 = 1: CH, CH ₃ positive, C, CH ₂ negative cnst11 = 2: C only.
RG	receiver gain	This is automatically adjusted using the commands xaua or rga .
P1, PL1	probe dependant pulse length and power level	These parameters are dependant on the individual probe and are loaded by the getprosol command.

4.3 Spectral processing

After the spectral acquisition has finished, the data has to be processed. You may do this either automatically using the **xaup** command or manually.

4.3.1 Automatic processing

The command **xaup** will invoke the automation AU program that is stored along with the processing parameters in the **aunmp** parameter. In this case the **aunmp** AU program is called **proc_1d**. (Except for the C13DEPT135p parameter-set, where **aunmp** is **proc_cpd135**, which takes the phase of the previous ¹³C experiment into account.)

Typing **xaup** will automatically process the data and thus it will generate a phase corrected spectrum, it will also perform a baseline correction and it will do an automatic integration of the peaks. By default, a plot will be created using the plot-layout which is also stored in the processing parameters. For the DEPT and APT parameter-sets this layout file is called **1D_X.xwp**.

4.3.2 Manual processing

The acquired data may also be processed manually. The steps that belong to the spectral processing are all arranged in the NMR data processing guide, which may be invoked from the **Processing → Data Processing Guide** menu.

Window function: A window function may be applied to the FID for smoother spectra or to enhance either resolution or signal to noise. The command **em** applies an exponential multiplication to the FID where the related parameter **lb** (line broadening) defines the value of the exponential factor. The command **gm** applies a gauss function multiplication which takes into account the two gauss factors **lb** and **gb**.

Exponential multiplication enhances signal to noise with the tradeoff of broader lines, while the gauss function enhances the resolution but decreases signal to noise.


For 1D ^{13}C spectra, usually an exponential multiplication is applied with **lb** = 1Hz.



Fourier transformation: After the application of the window function, the time domain data has to be Fourier transformed to yield a frequency domain spectrum. This is achieved with the command **ft**. Since exponential multiplication and Fourier transformation is often used consecutively, the command **ef** combines the **em** and the **ft** command.


Phase correction: The resulting spectrum will have to be phase corrected. There are two alternative mathematical algorithms for automatic phase correction procedures. They are executed by the commands **apk** and **apks**, respectively.

If – for some reason – only a part of the spectrum should be taken into account for phase correction, this may be done with the command **apkf**. The left and right limits of the region that shall be considered are defined by the processing parameters **absf1** and **absf2** respectively.

For DEPT-135 and APT with **cnst11** = 1 it may happen, that the automation routine for the phase correction will be off by 180 degrees. This would mean that for DEPT-135, for example that the CH and CH₃ peaks are negative and CH₂ peaks are positive. In this case, the values for **phc0** may just be changed by 180 degrees in the processing parameters.

It also is possible to manually phase correct the spectrum. Click the phase correction button  or type **ph** and select **manual phasing** from the dialogue window. The position of the reference- or pivot point is indicated by a red vertical line. By default, the highest peak is defined as the pivot point but if this peak is close to the center of the spectrum, it is advised to select a peak somewhere near the edge of the spectrum as pivot point. Move the cursor over the peak, press the right mouse button and select **Set Pivot Point** from the context menu.

Use zero order phase correction to correct the phase around the area of the pivot point: place the cursor over the  button, hold down the left mouse button and move the mouse up or down. Thus, adjust the 0 order phase value until the peak at the pivot point is positive and the baseline around it is flat. Then adjust the first order phase value in the same way by holding down the left mouse button over the  button. Move the mouse up and down until the peak on the opposite side of the spectrum – with respect to the reference peak – is positive and the baseline around this peak is flat as well.

By clicking the save-and-return button () , the phase correction will be applied to the spectrum and the values for zero- and first order phase

correction will be stored to the corresponding processing parameters: **phc0** and **phc1**. These parameters may now be used for phase correction of subsequent spectra by typing the command **pk**.


The command **efp** combines the commands **em**, **ft** and **pk**. Thus it applies an exponential multiplication to the FID (using the **lb** parameter). It then Fourier transforms the data and applies the phase correction values, stored as parameters **phc0** and **phc1**.

You may phase correct one spectrum of the series (e.g. DEPT-45 or even the C13CPD) automatically or manually and then use the same phase correction values (**phc0** and **phc1**) for the other spectra in the same series. This requires that you have kept the **o1p**, **sw** and **td** the same in all spectra!

Calibration and referencing: The chemical shift ppm axis may be calibrated. The **sref** command automatically looks for a peak at around 0ppm (± 0.5 ppm) and assumes that this is the TMS or another internal reference substance. It will then calibrate the axis of the spectrum in a way that this peak is at exactly 0ppm. If **sref** does not find a peak at around 0 ppm, it uses the solvent information for the axis calibration.

This method only works unambiguously if you have added TMS or another internal reference compound to your sample and if no peaks from your compound are in the area near 0ppm.

For the APT experiment, where **cnst11** = 2 is used, only quaternary C's are visible, therefore TMS can not be used for internal referencing!

You may also use the manual mode to calibrate the spectrum. Zoom into the peak of interest, which you'd like to set to a certain ppm value. To zoom into a certain region of a spectrum, hold down the left mouse button in the spectrum display and drag the cursor over the area of interest. Then click on this button  to enter the manual calibration mode. Place the red line of the cursor over the top of the peak that you'd like to use for calibration and click the left mouse button. Enter the desired frequency at the point of the cursor into the calibration window that opens up. Click **OK** and you're taken back to the default display and the axis calibration is stored into the processing parameters as the **sr** parameter. This parameter is also adjusted by the **sref** command.


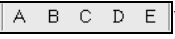

Keep in mind that the solvent peak might not be very intense and may even be invisible in DEPT and APT type experiments!

Baseline correction: The baseline of the spectrum may be corrected automatically by the command **abs**. This will then apply a polynomial baseline correction where the order of the polynomial function is defined by the processing parameter **absg**. The value for **absg** may range between 0 and 5. The default value for **absg** stored with the PROTON parameter set is 5.

absd uses an alternative mathematical algorithm than **abs**. It is, for example, used when a small peak lies on the foot of a large peak. In that case, **absd** allows you to correct the baseline around the small peak which can then be integrated. Usually **absd** is followed by **abs**.

Both of these baseline correction commands will also automatically integrate the peaks of the spectrum. Note that integrals are usually not evaluated for DEPT or APT type spectra.

Automatic baseline correction may also be applied only for parts of the spectrum. The processing parameters **absf1** and **absf2** define the left and the right limit of the spectral region (in ppm), where the baseline correction should be applied. Then use the command **absf** to correct only the selected region.

In order to enter the manual mode for baseline correction, click on the baseline button (). You may also type **bas** and select the option “correct baseline manually”. Here you may select different mathematical functions for the baseline (polynomial-, sine- and exponential functions). The corresponding factors for the functions may be adjusted by keeping the appropriate button pressed () while moving the mouse. You may also select individual baseline points and apply a cubic spline correction. By clicking on the difference button () , you may review the result before saving the changes.

4.3.3 Processing parameters

The processing parameters may be displayed by selecting the ProcPars tag in the TopSpin display window or by typing **edp**. Some of these processing parameters govern certain processing commands and may be optimized before the application of the respective processing command. Each parameter may also be accessed by typing it's name in lower case letters.

Table 4.2: Processing parameters that may be adjusted from the default parameter-set

Parameter	Explanation	Comments and possible values
SI	Size of the real spectrum	This corresponds to TD in the acquisition parameters. si defines the number of real data points that are used for the processing. If the value for si is larger than $\frac{1}{2}$ td , zero filling is applied since td is given in complex numbers. Zero filling smoothes spectra, so usually si = td . If si < $\frac{1}{2}$ td , then some of the acquired data points are not taken into account!
SR	Spectral reference	This parameter is altered by the spectral referencing. It is 0 if no axis referencing is performed.
LB	Line broadening $\exp(-\mathbf{lb} \cdot t)$	The lb governs the em and the gm command for the application of window functions. For em , the default value for lb is 1Hz. The larger lb , the broader the lines. For gm , lb has to be less than 0.
GB	Gaussian factor $\exp(-\mathbf{gb} \cdot t^2) \cdot \exp(-\mathbf{lb} \cdot t)$	The gb factor governs the gm window function together with lb . gb must be larger than 0 and smaller than 1.
PHC0, PHC1	phase correction for 0 and 1 st order	These values are entered by the phase correction routines and are applied by the

		processing commands pk, fp, efp.
ABSG	order of the polynomial for abs	$0 \leq \text{absg} \leq 5$. Usually absg = 5 works for most spectra.
ABSF1, ABSF2	left and right limit for absf and apkf	If only parts of the spectrum shall be considered for baseline- or phase correction, these parameters define the limits.

4.4 Post-processing

After the spectra are processed (Fourier transformed, phase corrected, referenced and baseline corrected), peaks may be picked. Usually integrals are not used.

4.4.1 Peak picking

Type **pp** in order to enter the peak picking dialog window. There are different options on how to perform peak picking. In order to display the picked peaks, right click in the spectrum display window and select “display properties” from the context menu and tick the box “Peak labels”.

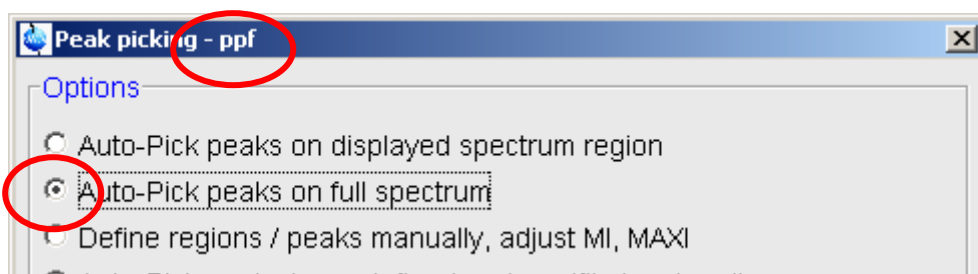
The picked peaks are stored in a peak list text file which may be displayed by selecting the “Peaks” tag in the main window. The peak list is interactive and you may correlate it with the spectrum and display spectrum and peak list at the same time. Right click in the peak list table and select “show spectrum” → “in correlated window” from the context menu. If you now move the mouse cursor over any entry in the list, the cursor in the spectrum will automatically jump to the corresponding peak in the spectrum. The peak list may also be exported as a text file or peak list file. Right click in the peak list window and select the “export” option from the context menu.


Automatic peak picking on the displayed region: Here the parameters **f1p** and **f2p** that define the left and right limit of the peak picking region are automatically set to the display region. One might have to adjust the values for **mi** and **maxi** however. **mi** defines the lower limit from where on peaks are considered as peaks and not as noise. The parameter **maxi** defines the upper limit where peaks that are larger than **maxi** are not considered anymore. If **mi** is too small, the peak picking routine will pick too many peaks in the noise floor. If **maxi** is smaller than the relative intensity of some peaks, these peaks will not be picked.



The automatic peak picking routine, which picks peaks in the full spectrum and which considers the parameters **mi** and **maxi** may also be executed without the graphical interface by typing **ppf**. If also the region – defined by **f1p** and **f2p** – should be considered, the command **pps** applies.


All possible command line commands for each of the options in the **pp** dialog box are displayed in the top frame of this dialog box.



Figure 4.3: peak picking dialog box and command line commands




Defining several regions for the automatic peak picking: You may enter the manual peak picking mode from the dialog box which is invoked by the **pp** command. Select “Define regions / peaks manually, adjust MI, MAXI”. You may also click on the peak picking button () in the main window in order to enter the manual mode for peak picking and region definition.

In the Manual peak picking mode you may define several regions to be considered for automatic peak picking. These regions can be defined by selecting the “define new peak picking range” button (). Then drag the mouse cursor over the region that you’d like to select. Every peak that is in the box will be considered for automatic peak picking which is started after you are finished defining all regions by clicking the “pick peaks on the defined region” button (). The peaks have to be within the box. Peaks that are larger than the box will not be considered as well as peaks that end below the lower limit of the box.

Save the peaks into a peak list and leave the peak picking mode by clicking the “return, save changes” button (

Manual peak picking: The manual peak picking mode is called up as described above (). With the “define peak manually” button (

All picked peaks are deleted by left clicking on the “delete all peaks” button (

4.5 Spectra interpretation

C-Atom multiplicities: DEPT and APT spectra are used along with C13CPD spectra to assign C-multiplicities. Along with the chemical shift information, this yields general information on functional groups. Usually a sequence of a C13CPD spectrum along with a DEPT-90 and a DEPT-135 spectrum are used to unambiguously assign multiplicities to all ¹³C peaks. Therefore these three spectra of a 50mM quinine solution in DMSO-d6 are displayed in Figure 4.4.

For the simplest comparison, the spectra are displayed in the multiple spectra view. In order to enter this mode click the multiple display button in


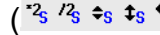
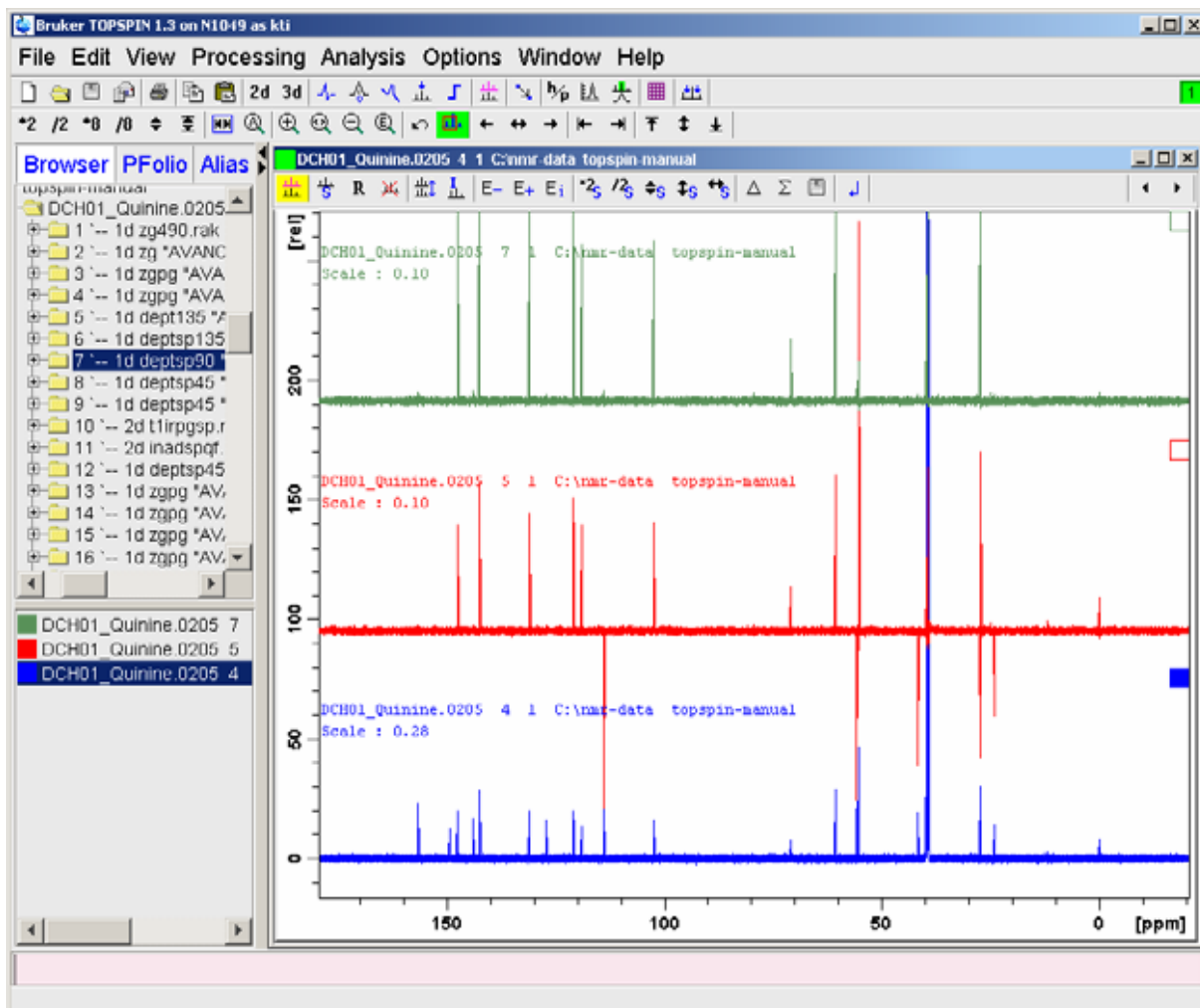
the TopSpin main window () . Drag and drop the spectra that you would like to overlay from the browser window into the display window. On the bottom of the browser side you may select the displayed spectra and all selective actions () in the overlay window will only work on them.

Figure 4.4: Spectra for CH multiplicity analysis: $C^{13}CPD$ (bottom) showing all peaks, DEPT-135 (middle), showing CH and CH_3 positive, CH_2 negative and DEPT-90 (top) showing only CH.



4.6 Possible pitfalls

Using the standard parameter sets and **getprosol** (see the chapter on data acquisition), will lead to satisfactory spectra without the need to change parameters.

However some common pitfalls and artifacts that may lead to unsatisfactory results are described here. We describe the most commonly observed phenomena and the causes as well as solutions to these relatively common things.

- Sometimes peaks show up in the spectra which are not expected for this type of multiplicity selection. For example in the DEPT-90 you might also observe peaks for CH_2 and CH_3 , which – in principle – should not be

there. Or in DEPT-135 some peaks are difficult to phase in either direction.

The reason for this is, that the **cnst2** that was used as the $^1J_{CH}$ coupling constant is only an average value. This might be quite different from the actual values of your coupling constants. Therefore it might help to run the spectra again with a better assumption for **cnst2**. Chances are however, that the dispersion of coupling constants is too large in the molecule. This will then lead to phasing problems in other regions of the spectra and a combination of both spectra might help for the assignment.

Keep in mind that typical values for $^1J_{CH}$ coupling constants are: $sp^3 \approx 125\text{Hz}$, $sp^2 \approx 167\text{Hz}$ and $sp \approx 250\text{Hz}$ and the default value for **cnst2** is 145Hz.

- A baseline which is tilted in one direction or is quite wiggly indicates a too low **de** value. This may occur when you try to acquire a ^{13}C direct observe spectrum with an inverse type probe (BBI, TXI, SEI or others). You may just set the **de** to larger values (try to set **de** to about 12 to 20us).
- Miscalibration of chemical shifts by up to 0.5ppm: This happens sometimes in the automation – either in IconNMR or using the **xaup** command – if no internal standard has been added. The reason is that the **sref** command finds a very small peak (possibly noise) close to 0ppm. It assumes that this is TMS and sets it to 0ppm. You may undo this by setting **sr** to 0Hz.

This is especially annoying, when comparing different spectra where one or a few are miscalibrated. Often it helps to set the **sr** to 0 for all spectra or – if this does not help – calibrate the spectra on an easy identifiable, common peak.

Keep in mind that the TMS reference peak will not show up in your DEPT spectra because of the multiplicity selection of the experiment.

5 The COSY Experiment

5.1 General information about the experiment

In normal 1D experiments signals may overlap and obscure the coupling information which may lead to difficulties in allocating a possible coupling partner. In such cases a 2D experiment, that spreads the information content of the spectrum in a second dimension, may help. The COSY is the easiest 2D NMR experiment showing crosspeaks whenever 2 protons are directly coupled via 2 or 3 bonds (so called geminal and vicinal couplings).

- The position of the crosspeaks yields information about directly coupled protons. This usually means, that you will get strong signals if the protons are bonded to adjacent carbon atoms.
- Depending on the type of the COSY, the pattern of the individual cross peak contains information about the coupling constants.

There are a few different types of this experiment around, two of those are introduced here. The easiest way to run such a spectrum is in a magnitude mode way. This means, that the spectrum is run without phase coherence and therefore the spectrum can not be phased after acquisition. Instead a magnitude calculation is performed which leads to unique rather broad peaks. This type of COSY can be run rather quick and is easy in terms of acquisition and interpretation. The main drawbacks are the loss of coupling constant information and the rather broad peaks. Especially the diagonal peaks can be too broad to keep track of crosspeaks near the diagonal. In such cases it is advisable to run a phase sensitive COSY. One special form of a phase sensitive COSY will be introduced here: the DQF-COSY (double quantum filtered COSY). The double quantum filter removes rather effectively magnetization caused by protons, that are not coupled to any other protons and hence don't give rise to any crosspeaks in a COSY. However, they may be so strong, that spurious signals are showing up, especially if the concentration of such protons is rather high like for example in 90% non deuterated water. In such cases a DQF-COSY is a good choice to improve the spectral quality. Furthermore, the crosspeaks exhibit a coupling pattern which includes some more information about direct and indirect coupling partners.

5.1.1 Pulse sequence and a few NMR details

Magnitude mode COSY:

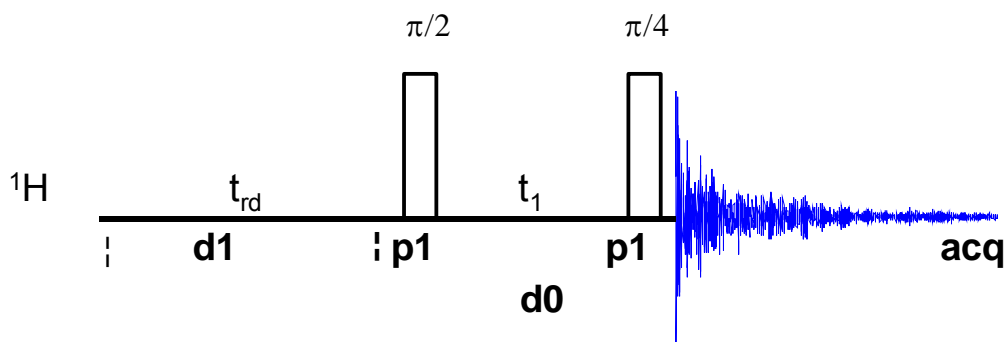
Several simple two-pulse programs can be used to record a magnitude mode COSY spectrum, e.g., `cosy`, `cosy45`, and `cosy90`. These vary with respect to the angle of the final pulse. Any value between 20° and 90° may be chosen for the final pulse angle. However, a pulse angle of 45° is recommended because this yields the best signal-to-noise ratio together with a simple cross peak structure in the final spectrum.

The signals acquired with one of these experiments have absorptive and dispersive lineshape contributions in both F1 and F2 dimensions. This means that it is impossible to phase the spectrum with all peaks purely absorptive,

and, as a consequence, the spectrum must be displayed in magnitude mode. A typical spectral resolution of 3 Hz/pt is sufficient for resolving large scalar couplings. In order to resolve small J-couplings fine digital resolution is required, which significantly increases the experimental time. In general, the DQF-COSY experiment is recommended if a higher resolution is desired.

The COSY-45 pulse sequence is shown in Figure 5.1. The pulse **p1** must be set to the appropriate 90° pulse length. The second pulse will then be automatically calculated by the pulse program.

Figure 5.1: Pulse sequence used for a magnitude COSY

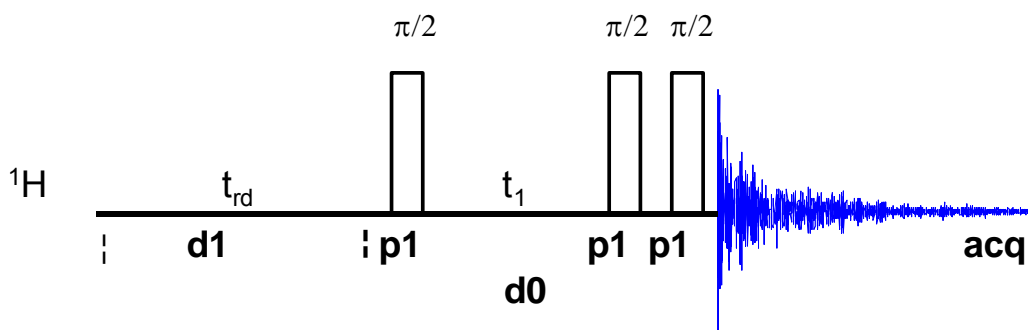


DQF-COSY:

The pulse sequence used for DQF-COSY consists of 3 90° pulses **p1** must be set to the appropriate 90° pulse length. Note that the DQF-COSY experiment is sensitive to high pulse-repetition rates, i.e., it is important to choose a long recycle delay time **d1** in order to avoid multiple-quantum artifacts in the spectrum. A suitable value for most samples is **d1** = 2 sec.

A graphical representation of the pulse program is given in Figure 5.2. Note that neither the time intervals nor the power levels are drawn to scale. For example **d1** is typically a few seconds while **p1** is typically a few microseconds.

Figure 5.2: DQF-COSY pulse sequence



5.2 Preparation and Acquisition

The steps that belong to the spectral acquisition are all arranged in the NMR spectra acquisition guide, which may be invoked from the **Acquisition → Data Acquisition Guide** menu.

5.2.1 Data acquisition step by step

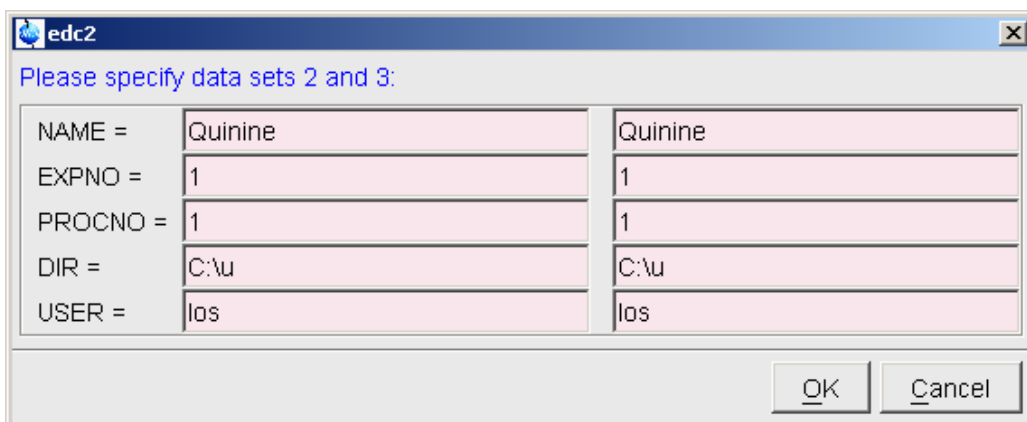
- Make sure that the sample tube is properly adjusted in the spinner if needed and insert it into the magnet. (For more information on sample preparation and handling, please refer to chapter 1.4 on page 15).
- If needed, make a new dataset, type **edc** or **new** or select **File → New** from the menu.

Here, the dataset name, the experiment number (**EXPNO**), the processing number (**PROCNO**), the directory and the user name are entered. All of these entries will become directories on the respective hard-disk. (For more information on directory structures, refer to chapter 1.3.1).

You may also choose the correct solvent in the **Solvent** field and select a parameter-set here in the **Experiment** field. The experimental parameters for acquisition, processing, plotting and output will be loaded from the selected parameter-set as if you would have typed **rpar**. You may also give a title.

- Lock the sample by typing **lock** and select the correct solvent.
- Match and tune the sample either manually by typing **wobb** and physically adjusting the matching and tuning sliders or screws on the probe – if you do not have an ATM probe – or automatically by typing **atma** – if you do have an ATM probe.
- Shim the sample either manually or by using the gradient shimming automation routine, type **gradshimau**.
- If you have not selected a parameter set yet (see above), type **rpar PROTON all**. This will select the 1D PROTON standard parameters. (For more information on parameter-sets, refer to chapter 1.3.2)
- Type **getprosol** and run a preparatory 1D proton experiment to judge spectra quality and to get a reference for sweep width and transmitter offset (see chapter 2).
- Increase the experiment number in the same experiment set by typing **edc** and changing experiment number and eventually the parameter set to COSY45SW or COSYDQFPHSW. You can also type in the command **iexpno** instead. This will just increase the experiment number by 1.
- If you have not selected a parameter set yet (see above), type **rpar COSY45SW all**. This will select the COSY standard parameters, which may be used as they are or which may be adjusted to your needs later. For a DQF-COSY type in **rpar COSYDQFPHSW all**. (For more information on parameter-sets, refer to chapter 1.3.2)

- Type **getprosol** to load the probe dependent parameters!
- Type in the command **edc2** to define the reference proton spectrum. Enter the correct experiment and processing number in the according field of data set 2.



- Adjust acquisition parameters or start the acquisition. We recommend that you use the automation mode by typing **xaua**. You may also start the receiver gain adjustment manually (type **rga**) and then start the acquisition and type **zg**.

5.2.2 Important acquisition parameters for this experiment

There are some acquisition parameters that may be modified for this experiment. The values of the parameters may be edited by clicking the AcquPars tag in the main window. You may access the full set of all acquisition parameters also by typing **eda** or a reduced set, where only parameters are displayed that are relevant for the selected pulse program by typing **ased**. Each parameter may also be accessed by typing its name in lower case letters.

In contrast to the 1D experiments there are 2 columns visible in the acquisition parameter editor now. The first column belongs to the direct or F2 dimension, the second one to the indirect or F1 dimension. Note that for homonuclear experiments, the nucleus in both dimensions and hence also the sweep width and the offset are the same.

Magnitude mode COSY:

Table 5.1: Acquisition parameters that may be adjusted from the default parameter-set

F2 Parameters		
Parameter	Explanation	Comments and possible values
PULPROG	pulse program for the acquisition	Use the cosy45qf pulse program where the pulse angle for the second pulse is already defined to be half of the first.
NS	number of scans	The minimum number of scans is 4. You can use any multiple of 4 to yield a more intense signal,

		however the experiment lasts longer then. The gradient assisted experiment can be run with a single scan.
DS	dummy scans	Typically 8-16
TD, AQ	time-domain, acquisition time	These 2 values depend on each other. To avoid too much data td in F2 is generally set to 1-2k.
SW	spectral width	sw (in ppm, or correspondingly swh in Hz) defines the width of the spectral window and it has to be large enough to incorporate all peaks of the spectrum. Typically a 1D proton experiment is run in advance of the COSY. Choose the whole range where signals are visible plus one additional ppm to either side. If you run a 1D proton spectrum in advance, define it as a reference with edc2 and start the acquisition with xaua , an automatic sweep range adjustment will be done.
O1P	transmitter offset	o1p (in ppm or o1 in Hz or sfo1 in MHz) defines the center of the spectral window (sw or swh). The signals should be centered around this value. If you run a 1D proton spectrum in advance, define it as reference with edc2 and start the acquisition with xaua , an automatic offset adjustment will be done.
D1	recycling delay between two scans	To save time, d1 is set to about $1.25 \cdot T1$. For most molecules, 2-3 s is an appropriate value.
RG	receiver gain	This is automatically adjusted using the commands xaua or rga .
P1, PL1	probe dependant pulse length and power level	These parameters are dependant on the individual probe and are loaded by the getprosol command. p1 defines the length of the 90° pulse at the power level pl1 .

F1 Parameters		
Parameter	Explanation	Comments and possible values
TD	number of experiments	This value determines how many points are recorded in the indirect dimension. 256 is an appropriate value.
FnMODE	determines quadrature detection in F1	Magnitude mode spectra are run without quadrature detection. Set this value to qf (quadrature off)
ND_010	number of incremented delays	1. There is only one incremented delay in the experiment.
SW	sweep width	For homonuclear experiments this is the same value as in F2
NUC1	nucleus in F1	For homonuclear experiments this is the same as in F2. Select ¹ H here.

DQF- COSY:

Table 5.2: Acquisition parameters that may be adjusted from the default parameter-set

F2 Parameters		
Parameter	Explanation	Comments and possible values
PULPROG	pulse program for the acquisition	The appropriate pulse program for a DQF-COSY is cosydfph.
NS	number of scans	The minimum number of scans is 8. You can use any multiple of 8 to yield a more intense signal, however the experiment lasts longer then.
DS	dummy scans	Typically 8-16
TD, AQ	time-domain, acquisition time	These 2 values depend on each other. To avoid too much data td in F2 is generally set to 1-2k.
SW	spectral width	sw (in ppm, or correspondingly swH in Hz) defines the width of the spectral window and it has to be large enough to incorporate all peaks of the spectrum. Typically a 1D proton experiment is run in advance of the COSY. Choose the whole range where signals are visible plus one additional ppm to either side If

		you run a 1D proton spectrum in advance, define it as reference with edc2 and start the acquisition with xaua , an automatic sweep width adjustment will be done.
O1P	transmitter offset	o1p (in ppm or o1 in Hz or sfo1 in MHz) defines the center of the spectral window (sw or swh). The signals should be centered around this value. If you run a 1D proton spectrum in advance, define it as reference with edc2 and start the acquisition with xaua , an automatic offset adjustment will be done.
D1	recycling delay between two scans	To save time, d1 is set to about $1.25 \cdot T1$. For most molecules, 2-3 s is an appropriate value.
RG	receiver gain	This is automatically adjusted using the commands xaua or rga .
P1, PL1	probe dependant pulse length and power level	These parameters are dependant on the individual probe and are loaded by the getprosol command. p1 defines the length of the 90° pulse at the power level pl1 .
F1 Parameters		
Parameter	Explanation	Comments and possible values
TD	number of experiments	This value determines how many points are recorded in the indirect dimension. 256 is an appropriate value.
FnMODE	determines quadrature detection in F1	For phase sensitive spectra you can choose States, TPPI or States-TPPI as quadrature detection method.
ND_010	number of incremented delays	1. There is only one incremented delay in the experiment.
SW	sweep width	For homonuclear experiments this is the same value as in F2
NUC1	nucleus in F1	For homonuclear experiments this is the same as in F2. Select ^1H here.

5.3 Spectral processing

After the spectral acquisition has finished, the data has to be processed. You may do this either automatically using the **xaup** command or manually.

5.3.1 Automatic processing

The command **xaup** will invoke the automation AU program that is stored along with the processing parameters in the **aunmp** parameter. In this case the **aunmp** AU program is called **proc_2dsym**.

Typing **xaup** will automatically process the data and thus it will generate a phase corrected spectrum, it will also perform a baseline correction and it will do an automatic integration of the peaks. By default, a plot will be created using the plot-layout which is also stored in the processing parameters. For the COSY45SW and the COSYDFPHSW parameter-sets this layout file is called **2D_hom.xwp**.

5.3.2 Manual processing

The acquired data may also be processed manually. The steps that belong to the spectral processing are all arranged in the NMR data processing guide, which may be invoked from the **Processing → Data Processing Guide** menu.

Magnitude mode COSY:

Window function: In 2D experiments the window functions can be used to diminish truncation artefacts, to enhance wanted signals over unwanted (for example diagonal peaks) and to improve the peak shape.

As the number of acquired points in a 2D experiment must be kept rather low for time reasons and to avoid too much data, the recorded FID is heavily truncated. The same issue occurs in the indirect dimension, although here the effect is even bigger, as the number of increments defines the number of points here. To avoid truncation artefacts (wiggles) in the resulting spectrum, sine-functions are used in both dimensions to force the FID to go down to zero.

To set the window functions it is easiest to click on the tag ProcPars and go to the sub menu Window Functions. For the parameter WDW several functions can be chosen from the pull down menu. Use SINE for a normal sine bell function or QSIN for a squared sine bell function, which approaches the zero value at the end of the FID a little smoother, than the pure sine bell.


SSB is a value that determines, by how much the sine function is shifted. If it is set to 0, the maximum is in the beginning of the curve. If it is set to a value n , the sine bell is shifted by π/n . For magnitude mode spectra **ssb** should be set to 0 in both dimensions to yield the best peak shape, best signal to noise for the cross peaks and best suppression of the diagonal peaks.

Fourier transformation: After the application of the window function, the time domain data has to be Fourier transformed to yield a frequency domain spectrum. This is achieved with the command **xfb**.

Phase correction: As no phase information is available in a magnitude mode spectrum, no phase correction is required. Instead a magnitude calculation is automatically done during the fourier transformation if you use the standard parameter set.

Calibration and referencing: The chemical shift ppm axis may be calibrated. The **sref** command automatically looks for a peak at around 0ppm (± 0.5 ppm) and assumes that this is the TMS or another internal reference substance. It will then calibrate the axes of the spectrum in a way that this peak is at exactly 0ppm in both dimensions. If **sref** does not find a peak at around 0 ppm, it uses the solvent information for the axis calibration.

This method only works unambiguously if you have added TMS or another internal reference compound to your sample and if no peaks from your compound are in the area around 0ppm.

You may also use the manual mode to calibrate the spectrum. Zoom into a diagonal peak of interest, which you'd like to set to a certain ppm value (e.g. a strong signal whose chemical shift is known). To zoom into a certain region of a spectrum, hold down the left mouse button in the spectrum display and drag the cursor over the area of interest. Then click on this button  to enter the manual calibration mode.

Place the cross of the cursor over the center of the peak that you'd like to use for calibration and click the left mouse button. Enter the desired frequency for both dimensions into the calibration window that opens up. Click **OK** and you're taken back to the default display and the axis calibration is stored into the processing parameters as the **sr** parameter. This parameter is also adjusted by the **sref** command.

Baseline correction: The baseline of the spectrum may be corrected automatically. This has to be done separately for both dimensions. Type **abs2** and then **abs1**. This will perform the correction first in the F2 dimension and then in F1. The commands will apply a polynomial baseline correction where the order of the polynomial function is defined by the processing parameter **absg**. The value of **absg** may range between 0 and 5. The default values of **absg** stored with the COSY45SW parameter set are 5 for both dimensions.

Automatic baseline correction may also be applied only for parts of the spectrum. The processing parameters **absf1** and **absf2**, which can be found under the ProcPars tag for both dimensions, define the left and the right limit of the spectral region (in ppm), where the baseline correction should be applied. Then use the command **absf1** and **absf2**, respectively to correct only the selected regions.

Symmetrization: To improve the spectral resolution in the indirect dimension and to suppress T_1 -noise, homonuclear 2D spectra may be symmetrized.

Theoretically, a spectrum is symmetric along the diagonal peaks. However, as the spectra are usually recorded with more points in the direct than in the indirect dimension and due to artifacts, this is usually not exactly the case. The symmetrization algorithm checks the intensity of every spectral point and compares it with the intensity of the symmetry related point on the opposite side of the diagonal. The lower intensity is then taken for both. This leads to narrower peaks in the indirect dimension and to a reduction of artifacts and

T₁-noise. However, if some intensity is found on both sides of the diagonal due to T₁-noise or other artifacts, symmetrization will produce something, that can hardly be distinguished from a real peak, due to the odd square shape that that even real peaks will have after symmetrization. So it is better to be conscious about problems that may result from symmetrization.

To symmetrize a magnitude mode COSY type **symt** on the command line or select **Processing** → **Symmetrize / Tilt** from the menu. In the dialog box, choose the option “Symmetrize COSY type spectrum”. After clicking **OK** the symmetrization will be applied. The same kind of symmetrization is done if you type in directly the command **sym**.

5.3.3 Processing parameters

The processing parameters may be displayed by selecting the ProcPars tag in the TopSpin display window or by typing **edp**. Some of these processing parameters govern certain processing commands and may be optimized before the application of the respective processing command. Each parameter may also be accessed by typing it's name in lower case letters.

Table 5.3: Processing parameters that may be adjusted from the default parameter-set

F2 Parameters		
Parameter	Explanation	Comments and possible values
SI	Size of the real spectrum	This corresponds to TD in the acquisition parameters. si defines the number of real data points that are used for the processing. If the value for si is larger than $\frac{1}{2}$ td , zero filling is applied since td is given in complex numbers. Zero filling smoothes spectra, so usually si = td . If si < $\frac{1}{2}$ td , then some of the acquired data points are not taken into account!
SR	Spectral reference	This parameter is altered by the spectral referencing. It is 0 if no axis referencing is performed.
WDW	Type of the window function	This parameter defines, which type of a window function will be applied in the direct dimension. Choose SINE or QSINE
SSB	Shifted sine bell	ssb determines where the maximum of the applied sine bell window function is. Set it to 0 for magnitude mode spectra.
PH_mod	Phase correction mode	No phase correction is applied. Set it to no.

ABSG	order of the polynomial for abs	$0 \leq \text{absg} \leq 5$. Usually absg = 5 works for most spectra.
BC_mod	Baseline correction on the FID	This value determines the polynomial order of the baseline correction that is performed on the FID. Set it to quad.

F2 Parameters

Parameter	Explanation	Comments and possible values
SI	Size of the real spectrum	In the indirect dimension of magnitude mode spectra zero filling is applied for si values that are larger than td . Zero filling smoothes spectra, so usually si = 2* td . If si < td , then some of the acquired data points are not taken into account!
SF	Spectral reference	This parameter is altered by the spectral referencing. It is 0 if no axis referencing is performed.
WDW	Type of the window function	This parameter defines, which type of a window function will be applied in the direct dimension. Choose SINE or QSINE
SSB	Shifted sine bell	ssb determines where the maximum of the applied sine bell window function is. Set it to 0 for magnitude mode spectra.
PH_mod	Phase correction mode	Instead of a phase correction a magnitude calculation is applied in the indirect dimension. Set it to mc.
MC2	Type of fourier transformation	The value of mc2 depends on the FnMODE that was chosen during acquisition. Here you have to set it to QF.

DQF- COSY:

Window function: In 2D experiments the window functions can be used to diminish truncation artefacts, to enhance wanted signals over unwanted (for example diagonal peaks) and to improve the peak shape.

As the number of acquired points in a 2D experiment must be kept rather low for time reasons and to avoid too much data, the recorded FID is heavily truncated. The same issue occurs in the indirect dimension, although here the effect is even bigger, as the number of increments defines the number of points here. To avoid truncation artefacts (wiggles) in the resulting spectrum,


sine-functions are used in both dimensions to force the FID to go down to zero.


To set the window functions it is easiest to click on the tag ProcPars and go to the sub menu Window Functions. For the parameter WDW several functions can be chosen from the pull down menu. Use SINE for a normal sine bell function or QSIN for a squared sine bell function, which approaches the zero value at the end of the FID a little smoother, than the pure sine bell.


SSB is a value that determines, by how much the sine function is shifted. If it is set to 0, the maximum is in the beginning of the curve. If it is set to a value n , the sine bell is shifted by π/n . For a phase sensitive COSY **ssb** should be set to 2 in both dimensions to yield the best peak shape and the best signal to noise. If there are still some wiggles occurring after the fourier transformation. Try some other values for **ssb** (3 or 4) and see whether this improves the appearance of the spectrum.

Fourier transformation: After the application of the window function, the time domain data has to be Fourier transformed to yield a frequency domain spectrum. This is achieved with the command **xfb**.


Phase correction: After fourier transformation, the spectrum needs to be phased. There is an au-program that takes care of an automatic phase correction. It can be started with the command **calcphomo**. The program calculates the required values for a phase correction in F1 and F2. After this the data needs to be fourier transformed again to apply the calculated phase correction.


It is also possible to manually phase correct the spectrum. Click the phase correction button  or type **ph** and select **manual phasing** from the dialogue window. The window will now show the spectrum with a cursor cross and some icons on top. Now some rather strong peaks should be selected that are spread as far as possible over the spectral range. To do this move the mouse, until the cursor is over a peak, click the right mouse button and select **Add** from the menu. That way, the rows and columns along the cursor cross will be added to the rows and columns that will be shown when going to the phasing itself. For a DQF-COSY it is best to choose some strong and rather isolated cross peaks and neglect the diagonal.


To adjust the phasing of the rows, click on the  button. The selected rows will be displayed as 1D spectra. The position of the reference- or pivot point is indicated by a red vertical line. By default, the highest peak of the first row is defined as the pivot point. However, as the highest point is usually a diagonal peak which is harder to phase than a cross peak, it is advised to select a cross peak somewhere near the edge of one of the rows as pivot point. Move the cursor over the peak, press the right mouse button and select **Set Pivot Point** from the context menu.

Use zero order phase correction to correct the phase around the area of the pivot point: place the cursor over the  button, hold down the left mouse button and move the mouse up or down. Thus, adjust the 0 order phase value until the baseline around the peak at the pivot point it is flat. Note that the peaks in a DQF-COSY are consisting of anti phase doublets or even multiplets. Hence it is not possible to phase the peak into a pure positive

peak. Instead, for an isolated cross signal the phased signal will consist of one positive and directly next to it one negative peak.

Then adjust the first order phase value in the same way by holding down the left mouse button over the  button. Move the mouse up and down until a cross peak on the opposite side of the spectral region is phased and the baseline around this peak is flat as well.


By clicking the save-and-return button () , the phase correction will be applied to the spectrum and the values for zero- and first order phase correction will be stored to the corresponding processing parameters of the F2 dimension: **phc0** and **phc1**. Whenever you type **xfb** these phase correction values will be taken into account, as long as the PH_mod under the ProcPars is set to pk.

Mostly, a phase correction of the columns is not necessary. However, if the resulting spectrum does not look perfectly phased in the indirect dimension, press the button  and proceed with the phasing of the columns exactly the same way, as with the rows. The resulting phase correction will then be automatically entered into the parameters **phc0** and **phc1** of the indirect dimension F1.

Leave the phasing by clicking the button .

Calibration and referencing: The chemical shift ppm axis may be calibrated. The **sref** command automatically looks for a peak at around 0ppm (± 0.5 ppm) and assumes that this is the TMS or another internal reference substance. It will then calibrate the axes of the spectrum in a way that this peak is at exactly 0ppm in both dimensions. If **sref** does not find a peak at around 0 ppm, it uses the solvent information for the axis calibration.

This method only works unambiguously if you have added TMS or another internal reference compound to your sample and if no peaks from your compound are in the area around 0ppm.

You may also use the manual mode to calibrate the spectrum. Zoom into a diagonal peak of interest, which you'd like to set to a certain ppm value (e.g. a strong signal whose chemical shift is known). To zoom into a certain region of a spectrum, hold down the left mouse button in the spectrum display and drag the cursor over the area of interest. Then click on this button  to enter the manual calibration mode.

Place the cross of the cursor over the center of the peak that you'd like to use for calibration and click the left mouse button. Enter the desired frequency for both dimensions into the calibration window that opens up. Click **OK** and you're taken back to the default display and the axis calibration is stored into the processing parameters as the **sr** parameter. This parameter is also adjusted by the **sref** command.

Baseline correction: The baseline of the spectrum may be corrected automatically. This has to be done separately for both dimensions. Type **abs2** and then **abs1**. This will perform the correction first in the F2 dimension and then in F1. The commands will apply a polynomial baseline correction where the order of the polynomial function is defined by the processing parameter **absg**. The value of **absg** may range between 0 and 5. The default

values of **absg** stored with the COSY45SW parameter set are 5 for both dimensions.

Automatic baseline correction may also be applied only for parts of the spectrum. The processing parameters **absf1** and **absf2**, which can be found under the ProcPars tag for both dimensions, define the left and the right limit of the spectral region (in ppm), where the baseline correction should be applied. Then use the command **absf1** and **absf2**, respectively to correct only the selected regions.

Symmetrization: To improve the spectral resolution in the indirect dimension and to suppress T₁-noise, homonuclear 2D spectra may be symmetrized.

Theoretically, a spectrum is symmetric along the diagonal peaks. However, as the spectra are usually recorded with more points in the direct than in the indirect dimension and due to artifacts, this is usually not exactly the case. The symmetrization algorithm checks the intensity of every spectral point and compares it with the intensity of the symmetry related point on the opposite side of the diagonal. The lower intensity is then taken for both. This leads to narrower peaks in the indirect dimension and to a reduction of artifacts and T₁-noise. However, if some intensity is found on both sides of the diagonal due to T₁-noise or other artifacts, symmetrization will produce something, that can hardly be distinguished from a real peak, due to the odd square shape that that even real peaks will have after symmetrization. So it is better to be conscious about problems that may result from symmetrization.

To symmetrize a DQF-COSY type **symt** on the command line or select **Processing → Symmetrize / Tilt** from the menu. In the dialog box, choose the option “Symmetrize phase sensitive spectrum”. After clicking **OK** the symmetrization will be applied. The same kind of symmetrization is applied if you type in directly the command **syma**.

5.3.4 Processing parameters

The processing parameters may be displayed by selecting the ProcPars tag in the TopSpin display window or by typing **edp**. Some of these processing parameters govern certain processing commands and may be optimized before the application of the respective processing command. Each parameter may also be accessed by typing it's name in lower case letters.

Table 5.4: Processing parameters that may be adjusted from the default parameter-set

F2 Parameters		
Parameter	Explanation	Comments and possible values
SI	Size of the real spectrum	This corresponds to TD in the acquisition parameters. si defines the number of real data points that are used for the processing. If the value for si is larger than $\frac{1}{2}$ td , zero filling is applied since td is given in complex numbers. Zero filling smoothes spectra, so usually si = td .

		If si < ½ td , then some of the acquired data points are not taken into account!
SR	Spectral reference	This parameter is altered by the spectral referencing. It is 0 if no axis referencing is performed.
WDW	Type of the window function	This parameter defines, which type of a window function will be applied in the direct dimension. Choose SINE or QSINE
SSB	Shifted sine bell	ssb determines where the maximum of the applied sine bell window function is. Set it to 2 for phase sensitive spectra.
PH_mod	Phase correction mode	This must be set to pk. The phase values of ph0 and ph1 will then automatically be applied in all proceeding fourier transformations.
ABSG	order of the polynomial for abs	$0 \leq \mathbf{absg} \leq 5$. Usually absg = 5 works for most spectra.
BC_mod	Baseline correction on the FID	This value determines the polynomial order of the baseline correction that is performed on the FID. Set it to quad.
F2 Parameters		
Parameter	Explanation	Comments and possible values
SI	Size of the real spectrum	If the value for si is larger than ½ td , zero filling is applied on phase sensitive spectra since td is given in complex numbers. Zero filling smoothes spectra, so usually si = td . If si < ½ td , then some of the acquired data points are not taken into account!
SF	Spectral reference	This parameter is altered by the spectral referencing. It is 0 if no axis referencing is performed.
WDW	Type of the window function	This parameter defines, which type of a window function will be applied in the direct dimension. Choose SINE or QSINE
SSB	Shifted sine bell	ssb determines where the maximum of the applied sine bell window function is. Set it to 2 for phase

		sensitive spectra.
PH_mod	Phase correction mode	This must be set to pk. The phase values of ph0 and ph1 will then automatically be applied in all proceeding fourier transformations.
MC2	Type of fourier transformation	The value of mc2 depends on the FnMODE that was chosen during acquisition. Set it to States, TPPI or States-TPPI, respectively.

5.4 Post-processing

After the spectra are processed (Fourier transformed, referenced and baseline corrected), peaks may be picked, eventually integrated and the spectrum may be plotted for further interpretation.

5.4.1 Peak picking

There are different options on how to perform peak picking.

In order to display the picked peaks, right click in the spectrum display window and select “display properties” from the context menu and tick the box “Peak labels”.

The picked peaks are stored in a peak list text file which may be displayed by selecting the “Peaks” tag in the main window. The peak list is interactive and you may correlate it with the spectrum and display spectrum and peak list at the same time. Right click in the peak list table and select “show spectrum” → “in correlated window” from the context menu. If you now move the mouse cursor over any entry in the list, the cursor in the spectrum will automatically jump to the corresponding peak in the spectrum. The peak list may also be exported as a text file or peak list file. Right click in the peak list window and select the “export” option from the context menu.

Automatic peak picking on the displayed region: To start the peak picking dialog window, type in the command **pp**.

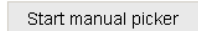


You have the option to append the data to a presumably already existing list. If this is not checked, the procedure will create a completely new peak list. If it is checked it may be wise to skip already existing peaks within that list, this means: not entering it a second time to the existing peaks.

The parameters that can be set include the region. Click on the “Set to” button. Here you can choose, whether you want to peak pick the complete processed spectral range, only the displayed region, the region that is defined by the F1/F2 parameters (which can be adjusted with the command **f1p** and **f2p**, respectively) or the region that was chosen during the last peak picking routine. Of course you can also type in the desired values directly in the peak picking dialog window. Note that the whole region can also be peak picked without opening the graphical interface with the command **ppf**,

whereas only the region defined by **f1p** and **f2p** is used when the command **pps** was applied.

The sensitivity can be altered in several ways. First a lower limit for the smallest intensity that should be recognized as a peak can be entered. You can type in any value for MI or go to the “Set to” button and choose either the lowest contour level, the MI value already stored with the dataset or the MI value used during the last peak picking routine. If the value is too low, too many peaks will be picked, if it is set to a too high value, weak peaks will be missed. A similar limitation can be applied to the maximum intensity. If MAXI is set to a smaller value than 1, every peak that has a higher intensity will not be picked. The diagonal gap allows to define a certain number of points around the diagonal, that will not be considered during peak picking. That way the diagonal peaks of homonuclear spectra will not be entered in the peak list. The smaller the resolution value is, the closer 2 peaks may be to be still considered as 2 separate peaks.

For a magnitude mode COSY only positive peaks need to be detected.

Manual peak picking: The manual peak picking mode can be started either from the peak picking dialog box by pressing the button  or directly from the main TopSpin window by clicking on the icon . You will enter the peak picking window. Set the cursor over a peak, click with the right mouse button and confirm, that the peak should be added to the peak list. To delete a peak, right click on an already marked peak and click on “Delete Peak From List”. If you click on “Annotate Peak” it is possible to add any desired assignment to the peak. Leave the dialog with the  button.

5.4.2 Projections

It is possible to show 1D spectra on either side of the 2D plot. This may be helpful, to identify cross peaks within spectrum. To toggle the display of the projections on, right click on the 2D spectrum and select the “Display Properties...”. In the dialog window toggle on the option “Show projections”. On the bottom it is possible to choose, whether the projections in F1, in F2 or in both dimensions should be visible. The moment, the projection display is turned on the positive projections are displayed above the spectrum and to the left as a default.

Display of a recorded 1D proton spectrum: Right click with the mouse over the displayed projection and choose the option “External projection”. A dialog box will open where you can type in the path information of the dataset that should be displayed.

Alternatively it is possible to start a projection display dialog box with the command **projd**. On top the option “Display 1D spectra along with the 2D spectrum” should be toggled on. If the checkbox is ticked it is possible to enter any 1D dataset for the F2 (left) and the F1 (right) dimension, respectively. After clicking **OK** the spectra will be displayed.

Display of internal projections: To switch back to the internal projections, right click over the projections and choose the option “Internal Projection”. The positive internal projection will be displayed again.

Alternatively it is again possible to use the command **projd** and toggle on the option “Display projections along with the 2D spectrum” on the top. After clicking **OK** the internal positive projections will be displayed.

5.5 Spectra interpretation

A typical magnitude mode and DQF-COSY are shown in Figure 5.3 and Figure 5.4, respectively.

Figure 5.3: Magnitude mode COSY of 50 mM Quinine

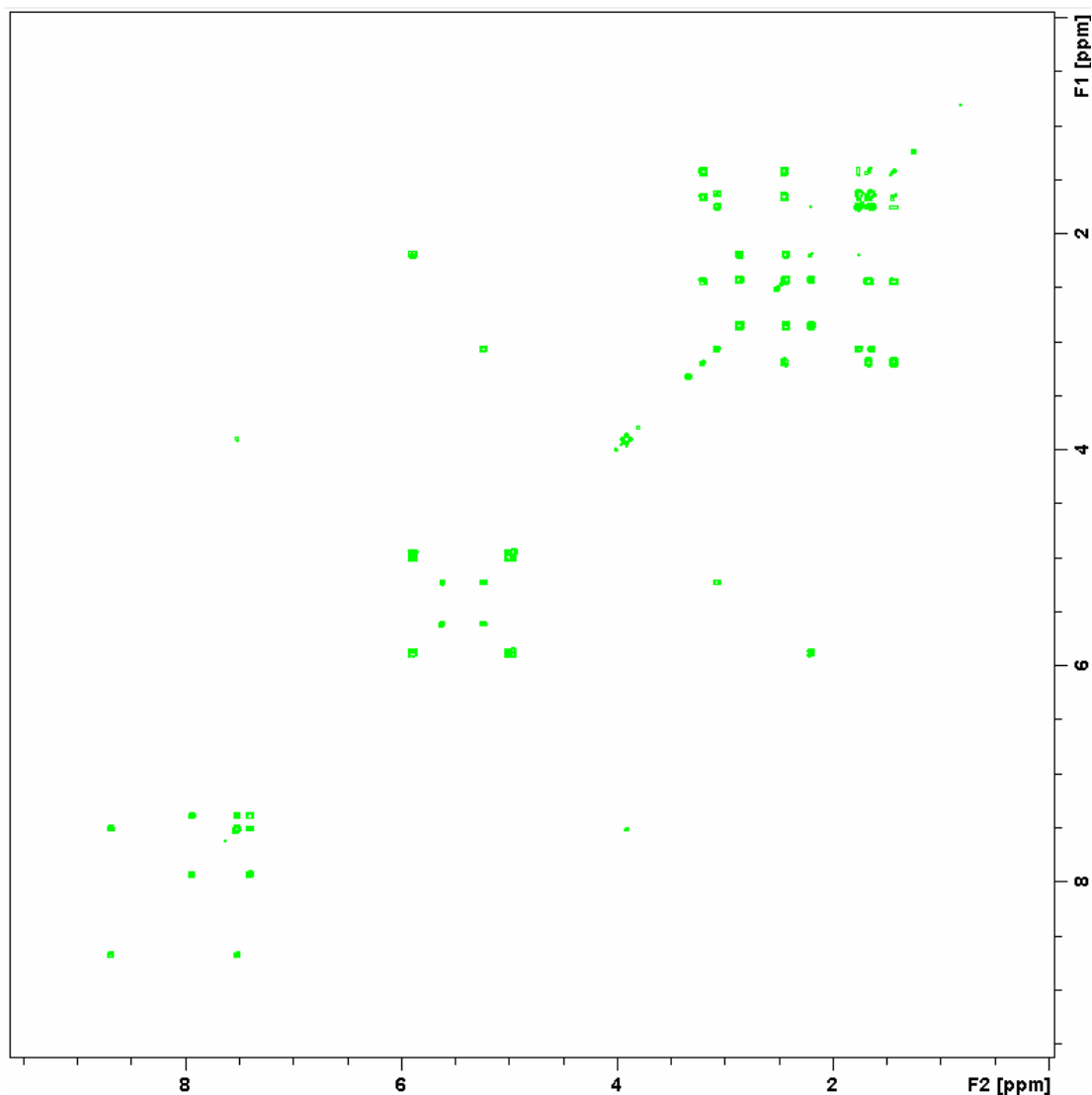
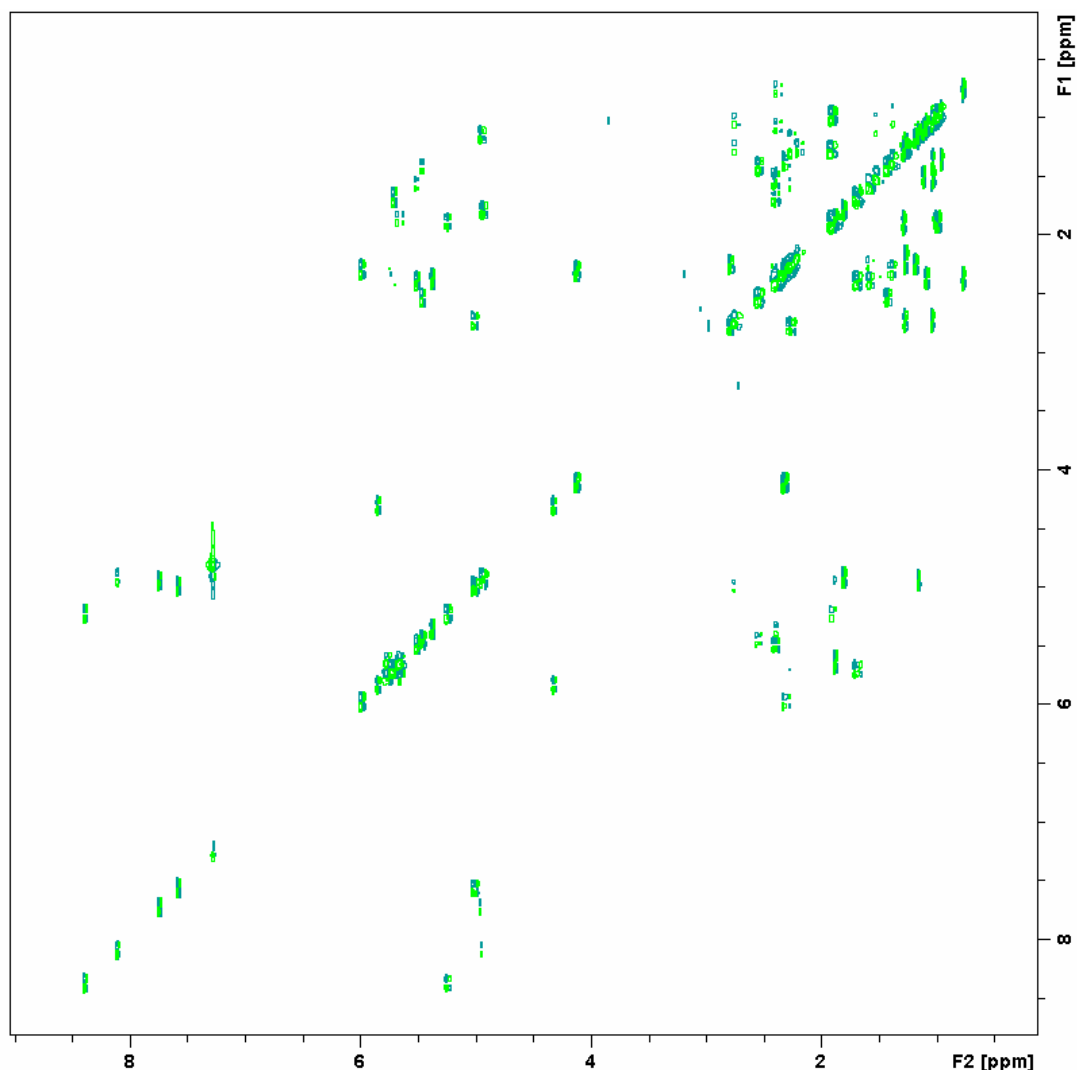


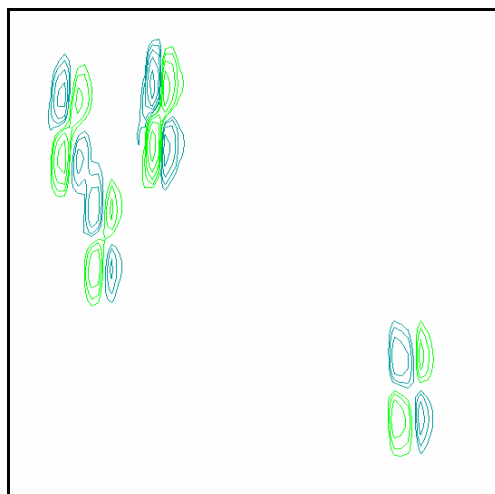
Figure 5.4: DQF-COSY of Cyclosporine.



Constitution and molecular structure: COSY spectra are recorded to yield information about neighbouring protons. Generally a cross peak can be retrieved from the spectrum if a scalar coupling between the two protons exists. The strongest peaks usually belong to protons separated by 2 or 3 bonds. This means, that generally neighbouring protons on an organic compound will give rise to a crosspeak. However, the appearance of cross signals only depends on the size of the scalar coupling constant. This means, that in favourable constitutional situations, peaks can be found for protons that are much further apart, than 3 bonds. This is especially often the case, if the protons are connected via double bonds or aromatic systems.

Coupling constants: In magnitude mode spectra, the coupling constants are obscured due to the magnitude calculation. However, in phase sensitive COSY's, like the DQF-COSY, some information about the coupling constants may be retrieved from the spectrum. In these spectra the peaks are partially pointing up and partially down leading to positive and negative contours for the cross signal. This is due to the coupling between the protons – in both dimensions, the peak will be showing up as an anti-phase doublet. The distance of the peaks is the coupling constant (Figure 5.5).

Figure 5.5: Enlargement of the cross peaks of a DQF-COSY showing the typical antiphase structure due to the active coupling in both dimensions.



Sometimes, a cross peak is split up in even more than these 4 portions. This is the case, if additionally to the active coupling (this is the coupling between the 2 protons giving rise to the cross peak), one or more passive couplings are existing. Passive couplings are showing up, if the proton observed in the direct dimension is coupled to more than one inequivalent proton. In contrast to the active coupling, a passive coupling will lead to an in-phase splitting that occurs only in the direct dimension F2.

5.6 Possible pitfalls

Using the standard parameter set, which is called up by typing **rpar COSY45SW all** or **rpar COSYDQFSW all**, respectively, and **getprosol** (see the chapter on data acquisition), will lead to satisfactory spectra without the need to change parameters.

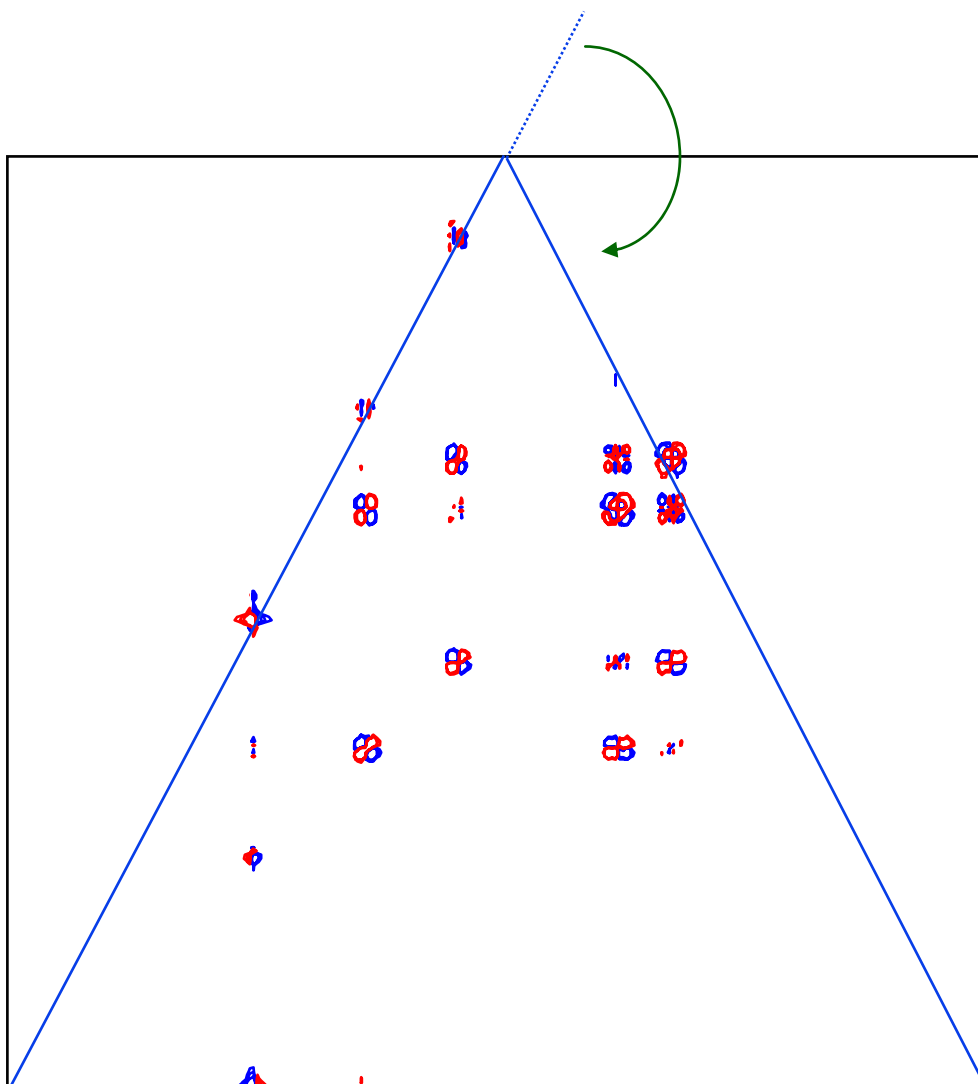
Some basic issues (lineshape, sample concentration and shim) should be checked already in the preparatory 1D proton experiment (see chapter 2)

However some common pitfalls and artifacts that may lead to unsatisfactory results are described here. We describe the most commonly observed phenomena and the causes as well as solutions to these relatively common things.

- For 2D experiments, spinning should always be turned off, as the spinning may introduce artefacts leading to criss cross noise in the spectra (see Figure 7.4). Note that you have to adjust the z and eventually also the z^2 shim, if you stop sample rotation. Therefore it is best to run already the preparatory 1D experiment without spinning.

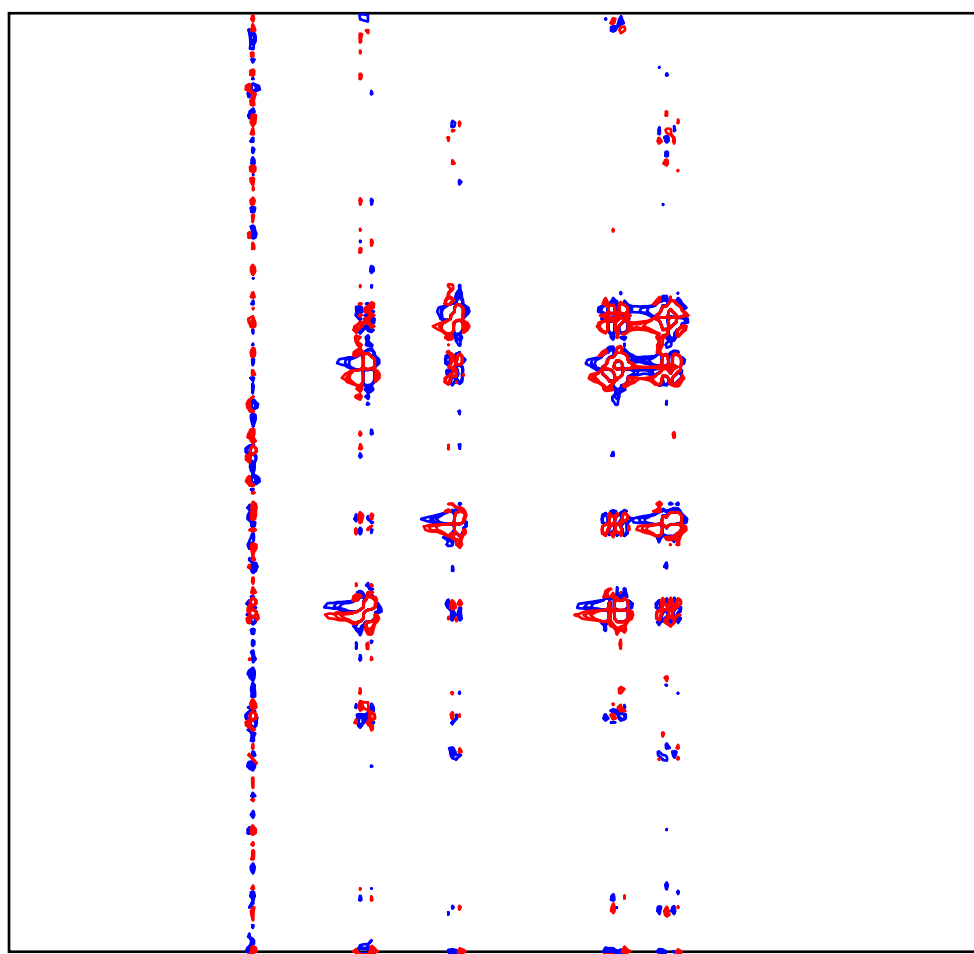
- Rapid scanning artifacts are very commonly found in COSY spectra, especially in the DQF-COSY. They will lead to an image of the diagonal peaks with double the slope (Figure 5.6).

Figure 5.6: Double quantum diagonal in a DQF-COSY due to rapid scanning artifacts.



- Wrong receiver gain adjustment may lead to quadrature artefacts along the F1 dimension, e.g. diamond patterns. Additionally the baseline will be distorted leading to high t_1 -noise (Figure 5.7). This is especially a problem with the DQF-COSY, as the first increment where the automatic receiver gain adjustment is usually performed on contains no signal intensity. To prevent this, never use the automatic receiver gain adjustment (**rga**) on a DQF-COSY. Instead use the receiver gain found for a normal 1D proton experiment or for the magnitude mode COSY.

Figure 5.7: DQF-COSY experiment. The receiver was overloaded leading to additional T_1 -noise.



- The number of scans and dummy scans needs to be a multiple of the minimum given in the pulse program. If that is not the case, the phase cycle is not completed which may lead to auxiliary diagonals parallel to the real diagonal (see Figure 6.4).
- Miscalibration of chemical shifts by up to 0.5ppm: This happens sometimes in the automation – either in IconNMR or using the **xaup** command – if no internal standard has been added. The reason is, that the **sref** command finds a very small peak (possibly noise) close to 0ppm.

It assumes that this is TMS and sets it to 0ppm. You may undo this by setting **sr** to 0Hz.

6 The TOCSY Experiment

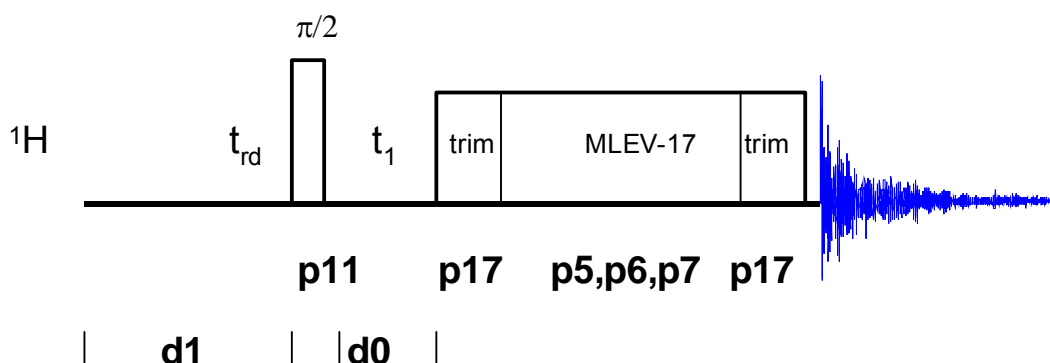
6.1 General information about the experiment

Whereas a COSY generally correlates protons via geminal or vicinal scalar spin couplings, a TOCSY can yield correlations of complete spin systems. Spin systems are groups of protons within a molecule that are within an uninterrupted chain of adjacent protons. Only quarternary carbon atoms or heteroatoms without directly bonded protons or with exchangeable protons will interrupt these spin systems. This means that a TOCSY can help drastically with the assignment of groups. For example on peptides, a TOCSY will yield a sub spectrum of every amino acid in the rows.

6.1.1 Pulse sequence and a few NMR details

The pulse sequence of a TOCSY consists of a 90° excitation pulse, followed by an incremented delay t_1 . The coherence transfer period of the TOCSY sequence occurs during a multiple-pulse spin-lock period. The multiple-pulse spin-lock sequence most commonly used is MLEV-17. The length of the spin-lock period determines how far the spin coupling network will be probed. A general rule of thumb is that $1/(10 J_{HH})$ should be allowed for each transfer step, and five transfer steps are typically desired for the TOCSY spectrum.

An advantage of a TOCSY is that pure absorption mode spectra with positive intensity peaks are created. In a traditional COSY, cross peaks have zero integrated intensity and the coherence transfer is restricted to directly spin-coupled nuclei. In a TOCSY, oscillatory exchange is established which proceeds through the entire coupling network so that there can be net magnetization transfer from one spin to another even without direct coupling. The isotropic mixing which occurs during the spin-lock period of the TOCSY sequence exchanges all in-phase as well as antiphase coherences.



6.2 Preparation and Acquisition

The steps that belong to the spectral acquisition are all arranged in the NMR spectra acquisition guide, which may be invoked from the **Acquisition → Data Acquisition Guide** menu.

6.2.1 Data acquisition step by step

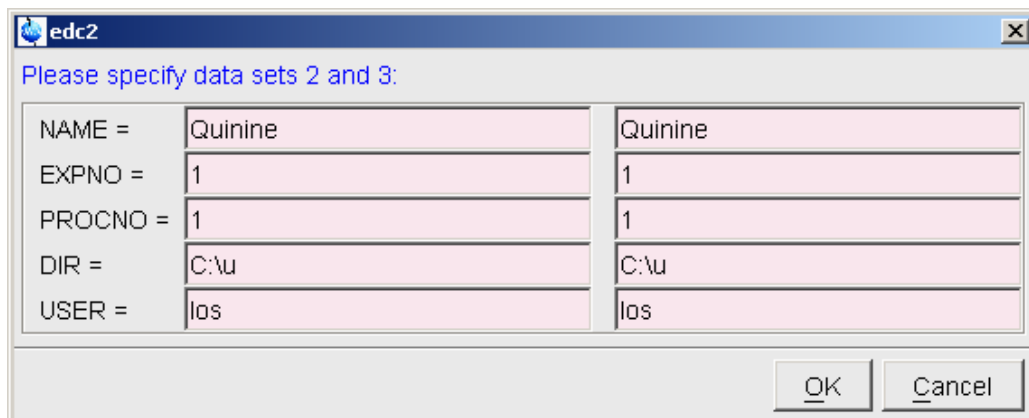
- Make sure that the sample tube is properly adjusted in the spinner if needed and insert it into the magnet. (For more information on sample preparation and handling, please refer to chapter 1.4 on page 15).
- If needed, make a new dataset, type **edc** or **new** or select **File → New** from the menu.

Here, the dataset name, the experiment number (**EXPNO**), the processing number (**PROCNO**), the directory and the user name are entered. All of these entries will become directories on the respective hard-disk. (For more information on directory structures, refer to chapter 1.3.1).

You may also choose the correct solvent in the **Solvent** field and select a parameter-set here in the **Experiment** field. The experimental parameters for acquisition, processing, plotting and output will be loaded from the selected parameter-set as if you would have typed **rpar**. You may also give a title.

- Lock the sample by typing **lock** and select the correct solvent.
- Match and tune the sample either manually by typing **wobb** and physically adjusting the matching and tuning sliders or screws on the probe – if you do not have an ATM probe – or automatically by typing **atma** – if you do have an ATM probe.
- Shim the sample either manually or by using the gradient shimming automation routine, type **gradshimau**.
- If you have not selected a parameter set yet (see above), type **rpar PROTON all**. This will select the 1D PROTON standard parameters. (For more information on parameter-sets, refer to chapter 1.3.2)
- Type **getprosol** and run a preparatory 1D proton experiment to judge spectra quality and to get a reference for sweep width and transmitter offset (see chapter 2).
- Increase the experiment number in the same experiment set by typing **edc** and changing experiment number and eventually the parameter set to MLEVPHSW. You can also type in the command **iexpno** instead. This will just increase the experiment number by 1.
- If you have not selected a parameter set yet (see above), type **rpar MLEVPHSW all**. This will select the TOCSY standard parameters, which may be used as they are or which may be adjusted to your needs later. (For more information on parameter-sets, refer to chapter 1.3.2)
- Type **getprosol** to load the probe dependent parameters!

- Type in the command **edc2** to define the reference proton spectrum. Enter the correct experiment and processing number in the according field of data set 2.



- Adjust acquisition parameters or start the acquisition. We recommend that you use the automation mode by typing **xaua**. You may also start the receiver gain adjustment manually (type **rga**) and then start the acquisition and type **zg**.

6.2.2 Important acquisition parameters for this experiment

There are some acquisition parameters that may be modified for this experiment. The values of the parameters may be edited by clicking the AcqPars tag in the main window. You may access the full set of all acquisition parameters also by typing **eda** or a reduced set, where only parameters are displayed that are relevant for the selected pulse program by typing **ased**. Each parameter may also be accessed by typing its name in lower case letters.

In contrast to the 1D experiments there are 2 columns visible in the acquisition parameter editor now. The first column belongs to the direct or F2 dimension, the second one to the indirect or F1 dimension. Note that for homonuclear experiments, the nucleus in both dimensions and hence also the sweep width and the offset are the same.

Table 6.1: Acquisition parameters that may be adjusted from the default parameter-set

F2 Parameters		
Parameter	Explanation	Comments and possible values
PULPROG	pulse program for the acquisition	Use the mlevph pulse program which yields a phase sensitive standard TOCSY using an MLEV sequence for the spin lock.
NS	number of scans	The minimum number of scans is 8. You can use any multiple of 8 to yield a more intense signal, however the experiment lasts longer then.
DS	dummy scans	Use 16 or better even 32 dummy scans.

		The rather long lasting spin lock pulse will slightly heat the sample. The real experiment should not be started, before a temperature equilibrium is reached again.
TD, AQ	time-domain, acquisition time	These 2 values depend on each other. To avoid too much data td in F2 is generally set to 2k.
SW	spectral width	sw (in ppm, or correspondingly swh in Hz) defines the width of the spectral window and it has to be large enough to incorporate all peaks of the spectrum. Typically a 1D proton experiment is run in advance of the TOCSY. Choose the whole range where signals are visible plus one additional ppm to either side. If you run a 1D proton spectrum in advance, define it as a reference with edc2 and start the acquisition with xaua , an automatic sweep range adjustment will be done.
O1P	transmitter offset	o1p (in ppm or o1 in Hz or sfo1 in MHz) defines the center of the spectral window (sw or swh). The signals should be centered around this value. If you run a 1D proton spectrum in advance, define it as reference with edc2 and start the acquisition with xaua , an automatic offset adjustment will be done.
D1	recycling delay between two scans	To save time, d1 is set to about $1.25 \cdot T1$. For most molecules, 1.5-2 s is an appropriate value.
D9	TOCSY mixing time	d9 determines the duration of the spin lock and hence over how many protons the magnetization will be distributed. It is normally set to 60 – 120 ms, leading to a magnetization transfer over 2-5 protons.
RG	receiver gain	This is automatically adjusted using the commands xaua or rga .
P1, PL1	probe dependant pulse length and high power level	These parameters are dependant on the individual probe and are loaded by the getprosol command. p1 defines the length of the 90° pulse at the power level pl1 .
P5, P6, P7 PL10	probe dependant pulse length and power level for the	These parameters are dependant on the individual probe and the magnetic field strength and are loaded by the

	spin lock	getprosol command. P6 defines the length of the 90° pulse at the power level p110 . P6 is usually in between 25 and 50 us and is field dependant. P5 and P7 are internally calculated from P6 and belong to a 60 and 180° pulse, respectively.
P15	Trim pulse	Pulse length of the trim pulse. This is generally set to about 2500 us. The trim pulse is applied at p110 and cleans up the magnetisation.
F1 Parameters		
Parameter	Explanation	Comments and possible values
TD	number of experiments	This value determines how many points are recorded in the indirect dimension. 256 is an appropriate value.
FnMODE	determines quadrature detection in F1	For phase sensitive spectra you can choose States, TPPI or States-TPPI as quadrature detection method.
ND_010	number of incremented delays	1. There is only one incremented delay in the experiment.
SW	sweep width	For homonuclear experiments this is the same value as in F2
NUC1	nucleus in F1	For homonuclear experiments this is the same as in F2. Select ¹ H here.

6.3 Spectral processing

After the spectral acquisition has finished, the data has to be processed. You may do this either automatically using the **xaup** command or manually.

6.3.1 Automatic processing

The command **xaup** will invoke the automation AU program that is stored along with the processing parameters in the **aunmp** parameter. In this case the **aunmp** AU program is called **proc_2dsym**.

Typing **xaup** will automatically process the data and thus it will generate a phase corrected spectrum, it will also perform a baseline correction and it will do an automatic integration of the peaks. By default, a plot will be created using the plot-layout which is also stored in the processing parameters. For the TOCSYPHSW parameter-set this layout file is called **2D_hom.xwp**.

6.3.2 Manual processing

The acquired data may also be processed manually. The steps that belong to the spectral processing are all arranged in the NMR data processing guide, which may be invoked from the **Processing → Data Processing Guide** menu.

Window function: In 2D experiments the window functions can be used to diminish truncation artefacts, to enhance wanted signals over unwanted (for example diagonal peaks) and to improve the peak shape.


As the number of acquired points in a 2D experiment must be kept rather low for time reasons and to avoid too much data, the recorded FID is heavily truncated. The same issue occurs in the indirect dimension, although here the effect is even bigger, as the number of increments defines the number of points here. To avoid truncation artefacts (wiggles) in the resulting spectrum, sine-functions are used in both dimensions to force the FID to go down to zero.


To set the window functions it is easiest to click on the tag ProcPars and go to the sub menu Window Functions. For the parameter WDW several functions can be chosen from the pull down menu. Use SINE for a normal sine bell function or QSIN for a squared sine bell function, which approaches the zero value at the end of the FID a little smoother, than the pure sine bell.

SSB is a value that determines, by how much the sine function is shifted. If it is set to 0, the maximum is in the beginning of the curve. If it is set to a value n , the sine bell is shifted by π/n . For a phase sensitive TOCSY **ssb** should be set to 2 in both dimensions. If there are still some wiggles occurring after the fourier transformation. Try some other values for **ssb** (3 or 4) and see whether this improves the appearance of the spectrum.


Fourier transformation: After the application of the window function, the time domain data has to be Fourier transformed to yield a frequency domain spectrum. This is achieved with the command **xfb**.


Phase correction: After fourier transformation, the spectrum needs to be phased. There is an au-program that takes care of an automatic phase correction. It can be started with the command **calcphhomo**. The program calculates the required values for a phase correction in F1 and F2. After this the data needs to be fourier transformed again to apply the calculated phase correction.

It is also possible to manually phase correct the spectrum. Click the phase correction button  or type **ph** and select **manual phasing** from the dialogue window. The window will now show the spectrum with a cursor cross and some icons on top. Now some rather strong peaks should be selected that are spread as far as possible over the spectral range. To do this move the mouse, until the cursor is over a peak, click the right mouse button and select **Add** from the menu. That way, the rows and columns along the cursor cross will be added to the rows and columns that will be shown when going to the phasing itself.


To adjust the phasing of the rows, click on the  button. The selected rows will be displayed as 1D spectra. The position of the reference- or pivot point is indicated by a red vertical line. By default, the highest peak of the first row


is defined as the pivot point. However, this may be a peak which is located in the central part of the spectrum. If this is the case it is advisable to define a peak somewhere close to the edge of one of the rows as pivot point. Move the cursor over the peak, press the right mouse button and select **Set Pivot Point** from the context menu.


Use zero order phase correction to correct the phase around the area of the pivot point: place the cursor over the  button, hold down the left mouse button and move the mouse up or down. Thus, adjust the 0 order phase value until the baseline around the peak at the pivot point is flat.

Then adjust the first order phase value in the same way by holding down the left mouse button over the  button. Move the mouse up and down until a cross peak on the opposite side of the spectral region is phased and the baseline around this peak is flat as well.

Note that it may not be possible to phase all peaks into pure absorption, as they may be dephased as well in the indirect dimension. If this is the case, some peaks will contain a negative part. Therefore it may be more useful to look at the baseline, than just at the peaks phase.


By clicking the save-and-return button (), the phase correction will be applied to the spectrum and the values for zero- and first order phase correction will be stored to the corresponding processing parameters of the F2 dimension: **phc0** and **phc1**. Whenever you type **xfb** these phase correction values will be taken into account, as long as the PH_mod under the ProcPars is set to pk.

Now the spectrum may still be out of phase in the indirect dimension. Press the button  and proceed with the phasing of the columns exactly the same way, as with the rows. The resulting phase correction will then be automatically entered into the parameters **phc0** and **phc1** of the indirect dimension F1.

Leave the phasing by clicking the button .

Calibration and referencing: The chemical shift ppm axis may be calibrated. The **sref** command automatically looks for a peak at around 0ppm (± 0.5 ppm) and assumes that this is the TMS or another internal reference substance. It will then calibrate the axes of the spectrum in a way that this peak is at exactly 0ppm in both dimensions. If **sref** does not find a peak at around 0 ppm, it uses the solvent information for the axis calibration.

This method only works unambiguously if you have added TMS or another internal reference compound to your sample and if no peaks from your compound are in the area around 0ppm.

You may also use the manual mode to calibrate the spectrum. Zoom into a diagonal peak of interest, which you'd like to set to a certain ppm value (e.g. a strong signal whose chemical shift is known). To zoom into a certain region of a spectrum, hold down the left mouse button in the spectrum display and drag the cursor over the area of interest. Then click on this button  to enter the manual calibration mode.

Place the cross of the cursor over the center of the peak that you'd like to use for calibration and click the left mouse button. Enter the desired frequency for both dimensions into the calibration window that opens up. Click **OK** and

you're taken back to the default display and the axis calibration is stored into the processing parameters as the **sr** parameter. This parameter is also adjusted by the **sref** command.

Baseline correction: The baseline of the spectrum may be corrected automatically. This has to be done separately for both dimensions. Type **abs2** and then **abs1**. This will perform the correction first in the F2 dimension and then in F1. The commands will apply a polynomial baseline correction where the order of the polynomial function is defined by the processing parameter **absg**. The value of **absg** may range between 0 and 5. The default values of **absg** stored with the MLEVPHSW parameter set are 5 for both dimensions.

Automatic baseline correction may also be applied only for parts of the spectrum. The processing parameters **absf1** and **absf2**, which can be found under the ProcPars tag for both dimensions, define the left and the right limit of the spectral region (in ppm), where the baseline correction should be applied. Then use the command **absf1** and **absf2**, respectively to correct only the selected regions.

Symmetrization: To improve the spectral resolution in the indirect dimension and to suppress T₁-noise, homonuclear 2D spectra may be symmetrized.

Theoretically, a spectrum is symmetric along the diagonal peaks. However, as the spectra are usually recorded with more points in the direct than in the indirect dimension and due to artifacts, this is usually not exactly the case. The symmetrization algorithm checks the intensity of every spectral point and compares it with the intensity of the symmetry related point on the opposite side of the diagonal. The lower intensity is then taken for both. This leads to narrower peaks in the indirect dimension and to a reduction of artifacts and T₁-noise. However, if some intensity is found on both sides of the diagonal due to T₁-noise or other artifacts, symmetrization will produce something, that can hardly be distinguished from a real peak, due to the odd square shape that that even real peaks will have after symmetrization. So it is better to be conscious about problems that may result from symmetrization.

To symmetrize a TOCSY type **symt** on the command line or select **Processing → Symmetrize / Tilt** from the menu. In the dialog box, choose the option "Symmetrize phase sensitive spectrum". After clicking **OK** the symmetrization will be applied. The same kind of symmetrization is applied if you type in directly the command **syma**.

6.3.3 Processing parameters

The processing parameters may be displayed by selecting the ProcPars tag in the TopSpin display window or by typing **edp**. Some of these processing parameters govern certain processing commands and may be optimized before the application of the respective processing command. Each parameter may also be accessed by typing it's name in lower case letters.

Table 6.2: Processing parameters that may be adjusted from the default parameter-set

F2 Parameters		
Parameter	Explanation	Comments and possible values

SI	Size of the real spectrum	This corresponds to TD in the acquisition parameters. si defines the number of real data points that are used for the processing. If the value for si is larger than $\frac{1}{2}$ td , zero filling is applied since td is given in complex numbers. Zero filling smoothes spectra, so usually si = td . If si < $\frac{1}{2}$ td , then some of the acquired data points are not taken into account!
SR	Spectral reference	This parameter is altered by the spectral referencing. It is 0 if no axis referencing is performed.
WDW	Type of the window function	This parameter defines, which type of a window function will be applied in the direct dimension. Choose SINE or QSINE
SSB	Shifted sine bell	ssb determines where the maximum of the applied sine bell window function is. Set it to 2 for phase sensitive spectra.
PH_mod	Phase correction mode	This must be set to pk. The phase values of ph0 and ph1 will then automatically be applied in all proceeding fourier transformations.
ABSG	order of the polynomial for abs	$0 \leq \mathbf{absg} \leq 5$. Usually absg = 5 works for most spectra.
BC_mod	Baseline correction on the FID	This value determines the polynomial order of the baseline correction that is performed on the FID. Set it to quad.
F2 Parameters		
Parameter	Explanation	Comments and possible values
SI	Size of the real spectrum	If the value for si is larger than $\frac{1}{2}$ td , zero filling is applied on phase sensitive spectra since td is given in complex numbers. Zero filling smoothes spectra, so usually si = td . If si < $\frac{1}{2}$ td , then some of the acquired data points are not taken into account!
SF	Spectral reference	This parameter is altered by the spectral referencing. It is 0 if no axis

		referencing is performed.
WDW	Type of the window function	This parameter defines, which type of a window function will be applied in the direct dimension. Choose SINE or QSINE
SSB	Shifted sine bell	ssb determines where the maximum of the applied sine bell window function is. Set it to 2 for phase sensitive spectra.
PH_mod	Phase correction mode	This must be set to pk. The phase values of ph0 and ph1 will then automatically be applied in all proceeding fourier transformations.
MC2	Type of fourier transformation	The value of mc2 depends on the FnMODE that was chosen during acquisition. Set it to States, TPPI or States-TPPI, respectively.

6.4 Post-processing

After the spectra are processed (Fourier transformed, referenced and baseline corrected), peaks may be picked and the spectrum may be plotted for further interpretation.

6.4.1 Peak picking

There are different options on how to perform peak picking.

In order to display the picked peaks, right click in the spectrum display window and select “display properties” from the context menu and tick the box “Peak labels”.

The picked peaks are stored in a peak list text file which may be displayed by selecting the “Peaks” tag in the main window. The peak list is interactive and you may correlate it with the spectrum and display spectrum and peak list at the same time. Right click in the peak list table and select “show spectrum” → “in correlated window” from the context menu. If you now move the mouse cursor over any entry in the list, the cursor in the spectrum will automatically jump to the corresponding peak in the spectrum. The peak list may also be exported as a text file or peak list file. Right click in the peak list window and select the “export” option from the context menu.

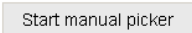


Automatic peak picking on the displayed region: To start the peak picking dialog window, type in the command **pp**.

You have the option to append the data to a presumably already existing list. If this is not checked, the procedure will create a completely new peak list. If it is checked it may be wise to skip already existing peaks within that list, this means: not entering it a second time to the existing peaks.

The parameters that can be set include the region. Click on the “Set to” button. Here you can choose, whether you want to peak pick the complete processed spectral range, only the displayed region, the region that is defined by the F1/F2 parameters (which can be adjusted with the command **f1p** and **f2p**, respectively) or the region that was chosen during the last peak picking routine. Of course you can also type in the desired values directly in the peak picking dialog window. Note that the whole region can also be peak picked without opening the graphical interface with the command **ppf**, whereas only the region defined by **f1p** and **f2p** is used when the command **pps** was applied.

The sensitivity can be altered in several ways. First a lower limit for the smallest intensity that should be recognized as a peak can be entered. You can type in any value for MI or go to the “Set to” button and choose either the lowest contour level, the MI value already stored with the dataset or the MI value used during the last peak picking routine. If the value is too low, too many peaks will be picked, if it is set to a too high value, weak peaks will be missed. A similar limitation can be applied to the maximum intensity. If MAXI is set to a smaller value than 1, every peak that has a higher intensity will not be picked. The diagonal gap allows to define a certain number of points around the diagonal, that will not be considered during peak picking. That way the diagonal peaks of homonuclear spectra will not be entered in the peak list. The smaller the resolution value is, the closer 2 peaks may be to still considered as 2 separate peaks.

For a TOCSY only positive peaks need to be detected.

Manual peak picking: The manual peak picking mode can be started either from the peak picking dialog box by pressing the button  or directly from the main TopSpin window by clicking on the icon . You will enter the peak picking window. Set the cursor over a peak, click with the right mouse button and confirm, that the peak should be added to the peak list. To delete a peak, right click on an already marked peak and click on “Delete Peak From List”. If you click on “Annotate Peak” it is possible to add any desired assignment to the peak. Leave the dialog with the  button.

6.4.2 Projections

It is possible to show 1D spectra on either side of the 2D plot. This may be helpful, to identify cross peaks within spectrum. To toggle the display of the projections on, right click on the 2D spectrum and select the “Display Properties...”. In the dialog window toggle on the option “Show projections”. On the bottom it is possible to choose, whether the projections in F1, in F2 or in both dimensions should be visible. The moment, the projection display is turned on the positive projections are displayed above the spectrum and to the left as a default.

Display of a recorded 1D proton spectrum: Right click with the mouse over the displayed projection and choose the option “External projection”. A dialog box will open where you can type in the path information of the dataset that should be displayed.

Alternatively it is possible to start a projection display dialog box with the command **projd**. On top the option “Display 1D spectra along with the 2D spectrum” should be toggled on. If the checkbox is ticked it is possible to enter any 1D dataset for the F2 (left) and the F1 (right) dimension, respectively. After clicking **OK** the spectra will be displayed.

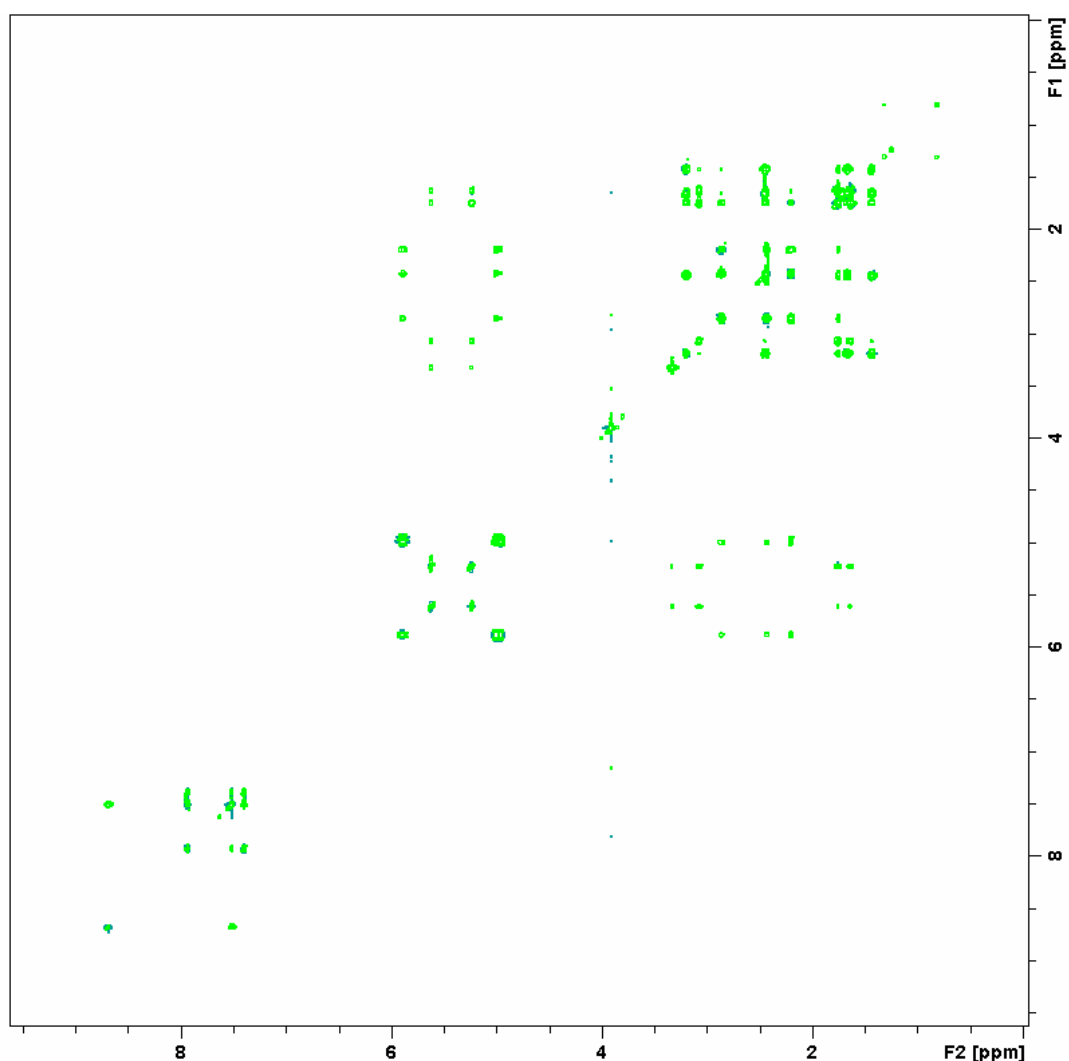
Display of internal projections: To switch back to the internal projections, right click over the projections and choose the option “Internal Projection”. The positive internal projection will be displayed again.

Alternatively it is again possible to use the command **projd** and toggle on the option “Display projections along with the 2D spectrum” on the top. After clicking **OK** the internal positive projections will be displayed.

6.5 Spectra interpretation

A TOCSY spectrum of 50 mM Quinine in DMSO is shown in Figure 6.1.

Figure 6.1: TOCSY of 50 mM Quinine in DMSO



Constitution and molecular structure: In contrast to a COSY spectrum that will show crosspeaks only if the protons are directly scalarly coupled, a

TOCSY will show cross peaks from one proton to almost all other protons in the same spin system. Whether really all cross peaks are visible depends on the mixing time **d9**. The longer it is, the further the magnetization will be transferred, but at the same time a cross peak to a closer proton may be diminished in its intensity with a longer mixing time. However, generally all protons within the same spin system will show the same peaks. Therefore a TOCSY can also be very helpful in the assignment of peaks that are situated in crowded areas of the spectrum. As long as it is in the same spin system with a rather isolated peak, the exact chemical shift can be determined in the row of this peak.

6.6 Possible pitfalls

Using the standard parameter set, which is called up by typing **rpar MLEVPHSW all** and **getprosol** (see the chapter on data acquisition), will lead to satisfactory spectra without the need to change parameters.

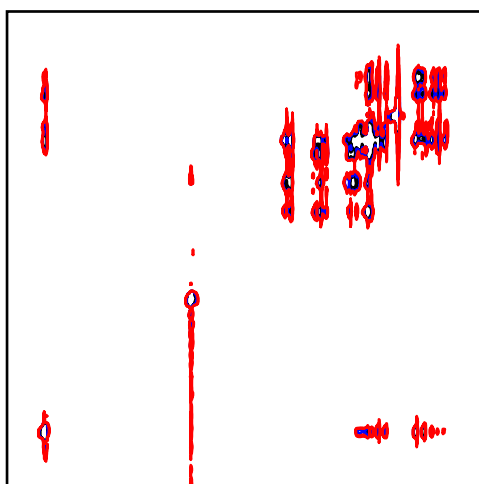
Some basic issues (lineshape, sample concentration and shim) should be checked already in the preparatory 1D proton experiment (see chapter 2)

However some common pitfalls and artifacts that may lead to unsatisfactory results are described here. We describe the most commonly observed phenomena and the causes as well as solutions to these relatively common things.

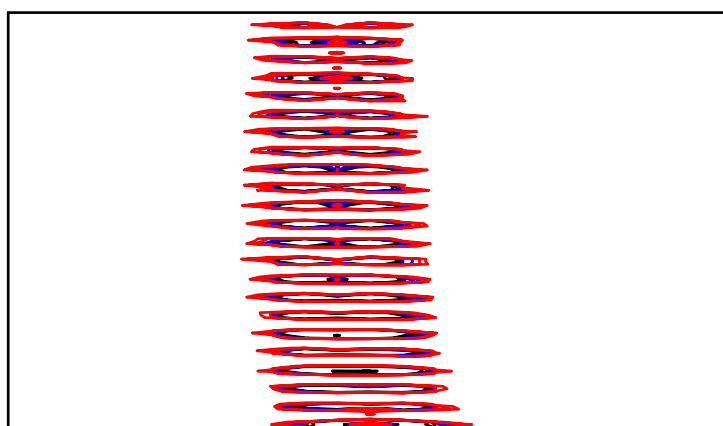
- For 2D experiments, spinning should always be turned off, as the spinning may introduce artefacts leading to criss cross noise in the spectra (see Figure 7.4). Note that you have to adjust the z and eventually also the z^2 shim, if you stop sample rotation. Therefore it is best to run already the preparatory 1D experiment without spinning.
- Miscalibration of chemical shifts by up to 0.5ppm: This happens sometimes in the automation – either in IconNMR or using the **xaup** command – if no internal standard has been added. The reason is that the **sref** command finds a very small peak (possibly noise) close to 0ppm. It assumes that this is TMS and sets it to 0ppm. You may undo this by setting **sr** to 0Hz.
- In a TOCSY the first increment contains less signal than the proceeding increments with longer delays. This may lead to an overload of the receiver as the automatic receiver gain adjustment is done on the first increment. In the spectrum this results in quadrature artefacts along the F1 dimension, e.g. diamond patterns. Additionally the baseline will be distorted leading to high T_1 -noise (Figure 5.7). To prevent this, never use the automatic receiver gain adjustment (**rga**) on a TOCSY. Instead use the receiver gain found for a normal 1D proton experiment or for the magnitude mode COSY.

- Especially in TOCSY experiments, heating of the sample due to the rather long lasting spin lock pulse can not be completely prevented. Hence the temperature of the sample will rise a little bit upon the start of the experiment. After a short time, a temperature equilibrium will be reached again. It is important, not to start acquiring data before the equilibrium is established, otherwise the peaks will become distorted due to the different temperature at which the first increments were run (Figure 6.2). To ensure this, choose enough dummy scans. At least 32 should be taken but it may be better to wait a little longer. If you are not sure, whether sample heating is responsible for the bad lineshape, fourier transform the spectrum only in the direct dimension with the command **xf2** and check whether the signals are shifting during the first increments (Figure 6.3).

Figure 6.2: Distorted baseline and bad lineshape in a TOCSY due to temperature adjustment of the sample during the first increments.

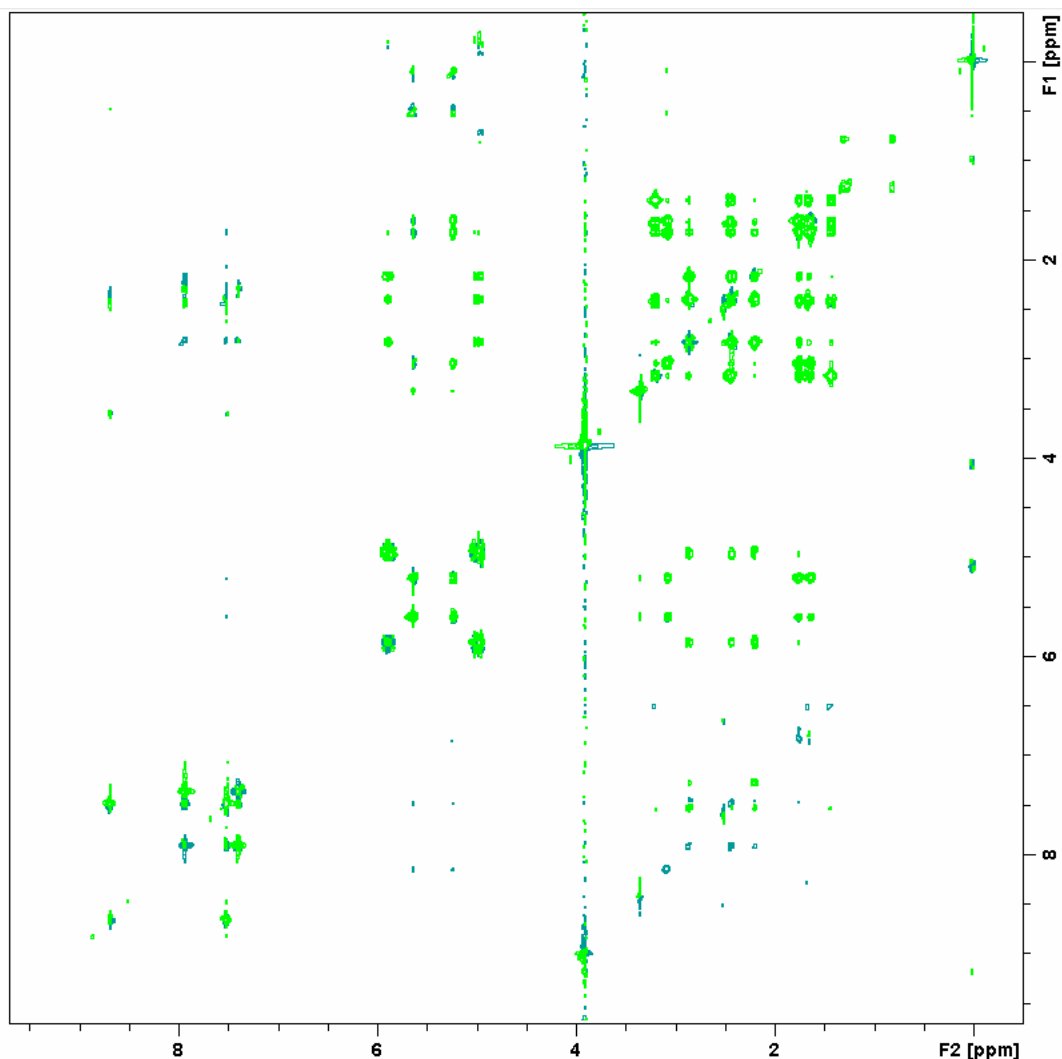


*Figure 6.3: After processing the raw data of the spectrum shown in Figure 6.2 with **xf2**, only the rows are fourier transformed. The shift of the signal during the first increments is obvious here.*



- The number of scans and dummy scans needs to be a multiple of the minimum given in the pulse program. If that is not the case, the phase cycle is not completed which may lead to auxiliary diagonals parallel to the real diagonal (Figure 6.4).

Figure 6.4: TOCSY run with only 2 instead of the 8 scan, necessary for complete phase cycling. Artifacts appear parallel to the diagonal on the “quarterlines” of the spectrum.



7 The NOESY Experiment

7.1 General information about the experiment

Whereas a COSY generally correlates protons via geminal or vicinal scalar spin couplings, a NOESY shows correlations of protons, that are spatially close, no matter whether they are as well close through bonds and therefore scalarly coupled or not. The interaction that is important for an NOE transfer is the so called dipolar coupling, which can only be directly observed in solid or partially oriented phases. However, the NOE (**N**uclear **O**verhauser **E**ffect) also leads to an intensity change of a signal, if the signal of a coupled proton is saturated. This effect is based on the relaxation behaviour and it can lead to a signal enhancement as well as to a signal reduction.

7.1.1 Pulse sequence and a few NMR details

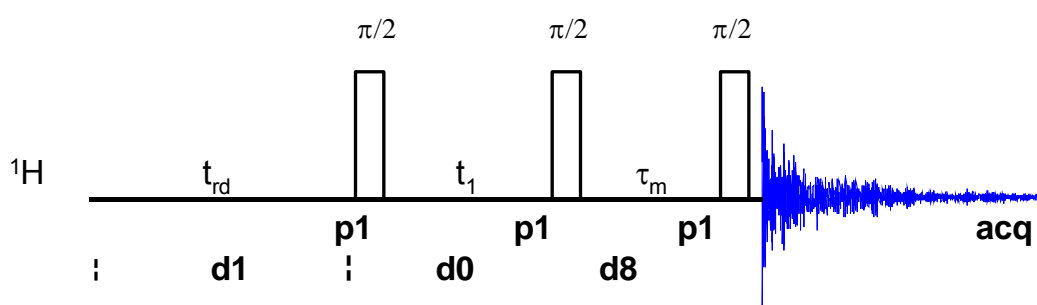
The basic NOESY sequence consists of three $\pi/2$ pulses. The first pulse creates transverse spin magnetization. This precesses during the evolution time t_1 , which is incremented during the course of the 2D experiment. The second pulse produces longitudinal magnetization equal to the transverse magnetization component orthogonal to the pulse direction. Thus, the basic idea is to produce an initial situation for the mixing period τ_m . Note that, for the basic NOESY experiment, τ_m is kept constant throughout the 2D experiment. The third pulse creates transverse magnetization from the remaining longitudinal magnetization. Acquisition begins immediately following the third pulse, and the transverse magnetization is observed as a function of the time t_2 . The NOESY spectrum is generated by a 2D Fourier transform with respect to t_1 and t_2 .

Axial peaks, which originate from magnetization that has relaxed during τ_m , can be removed by the appropriate phase cycling.

NOESY spectra can be obtained in 2D absorption mode. Occasionally, COSY-type artifacts appear in the NOESY spectrum; however, these are easy to identify by their anti-phase multiplet structure.

The NOESY pulse sequence is shown in Figure 7.1. The delay d_8 determines the length of the mixing period, during which NOE buildup occurs.

Figure 7.1: NOESY Pulse Sequence



7.2 Preparation and Acquisition

The steps that belong to the spectral acquisition are all arranged in the NMR spectra acquisition guide, which may be invoked from the **Acquisition → Data Acquisition Guide** menu.

7.2.1 Data acquisition step by step

- Make sure that the sample tube is properly adjusted in the spinner if needed and insert it into the magnet. (For more information on sample preparation and handling, please refer to chapter 1.3).
- If needed, make a new dataset, type **edc** or **new** or select **File → New** from the menu.

Here, the dataset name, the experiment number (**EXPNO**), the processing number (**PROCNO**), the directory and the user name are entered. All of these entries will become directories on the respective hard-disk. (For more information on directory structures, refer to chapter 1.3).

You may also choose the correct solvent in the **Solvent** field and select a parameter-set here in the **Experiment** field. The experimental parameters for acquisition, processing, plotting and output will be loaded from the selected parameter-set as if you would have typed **rpar**. You may also give a title.

- Lock the sample by typing **lock** and select the correct solvent.
- Match and tune the sample either manually by typing **wobb** and physically adjusting the matching and tuning sliders or screws on the probe – if you do not have an ATM probe – or automatically by typing **atma** – if you do have an ATM probe.
- Shim the sample either manually or by using the gradient shimming automation routine, type **gradshimau**.
- If you have not selected a parameter set yet (see above), type **rpar PROTON all**. This will select the 1D PROTON standard parameters. (For more information on parameter-sets, refer to chapter 1.3.2)
- Type **getprosol** and run a preparatory 1D proton experiment to judge spectra quality and to get a reference for sweep width and transmitter offset (see chapter 2).
- Increase the experiment number in the same experiment set by typing **edc** and changing experiment number and eventually the parameter set to NOESYPSW. You can also type in the command **ixpno** instead. This will just increase the experiment number by 1.
- If you have not selected a parameter set yet (see above), type **rpar NOESYPSW all**. This will select the NOESY standard parameters, which may be used as they are or which may be adjusted to your needs later. (For more information on parameter-sets, refer to chapter 1.3.2)
- Type **getprosol** to load the probe dependent parameters!

- Type in the command **edc2** to define the reference proton spectrum. Enter the correct experiment and processing number in the according field of data set 2.

	Quinine	Quinine
NAME =	Quinine	Quinine
EXPNO =	1	1
PROCNO =	1	1
DIR =	C:\u	C:\u
USER =	los	los

- Adjust acquisition parameters or start the acquisition. We recommend that you use the automation mode by typing **xaua**. You may also start the receiver gain adjustment manually (type **rga**) and then start the acquisition and type **zg**.

7.2.2 Important acquisition parameters for this experiment

There are some acquisition parameters that may be modified for this experiment. The values of the parameters may be edited by clicking the AcqPars tag in the main window. You may access the full set of all acquisition parameters also by typing **eda** or a reduced set, where only parameters are displayed that are relevant for the selected pulse program by typing **ased**. Each parameter may also be accessed by typing its name in lower case letters.

In contrast to the 1D experiments there are 2 columns visible in the acquisition parameter editor now. The first column belongs to the direct or F2 dimension, the second one to the indirect or F1 dimension. Note that for homonuclear experiments, the nucleus in both dimensions and hence also the sweep width and the offset are the same.

Table 7.1: Acquisition parameters that may be adjusted from the default parameter-set

F2 Parameters		
Parameter	Explanation	Comments and possible values
PULPROG	pulse program for the acquisition	Use the noesyph pulse program which yields a phase sensitive standard NOESY.
NS	number of scans	The minimum number of scans is 8. You can use any multiple of 8 to yield a more intense signal, however the experiment lasts longer then.
DS	dummy scans	Typically 8-16 are used.
TD, AQ	time-domain, acquisition time	These 2 values depend on each other. To avoid too much data td in F2 is generally set to 2k.
SW	spectral width	sw (in ppm, or correspondingly swh in Hz) defines the width of the spectral window and it has to be large enough to incorporate all peaks of the spectrum. Typically a 1D proton experiment is run in advance of the NOESY. Choose the whole range where signals are visible plus one additional ppm to either side. If you run a 1D proton spectrum in advance, define it as a reference with edc2 and start the acquisition with xaua, an automatic sweep range adjustment will be done.
O1P	transmitter offset	o1p (in ppm or o1 in Hz or sfo1 in MHz) defines the center of the spectral window (sw or swh). The signals should be centered around this value. If you run a 1D proton spectrum in advance, define it as reference with edc2 and start the acquisition with xaua, an automatic offset adjustment will be done.
D1	recycling delay between two scans	To save time, d1 is set to about $1.25 \cdot T_1$. For most molecules, 1.5-2 s is an appropriate value.
D8	NOESY mixing time	d8 determines the duration of mixing time. It largely depends on the relaxation behaviour of the

		investigated molecule. Generally it is set to 600-900 ms for small organic compounds and to about 150 ms for proteins. The longer the T ₁ -relaxation time, the longer d8 should be. To determine the optimum value, the relaxation time needs to be determined with an inversion recovery experiment (see below).
RG	receiver gain	This is automatically adjusted using the commands xaua or rga .
P1, PL1	probe dependant pulse length and high power level	These parameters are dependant on the individual probe and are loaded by the getprosol command. p1 defines the length of the 90° pulse at the power level pl1 .
F1 Parameters		
Parameter	Explanation	Comments and possible values
TD	number of experiments	This value determines how many points are recorded in the indirect dimension. 256 is an appropriate value.
FnMODE	determines quadrature detection in F1	For phase sensitive spectra you can choose States, TPPI or States-TPPI as quadrature detection method.
ND_010	number of incremented delays	1. There is only one incremented delay in the experiment.
SW	sweep width	For homonuclear experiments this is the same value as in F2
NUC1	nucleus in F1	For homonuclear experiments this is the same as in F2. Select ¹ H here.

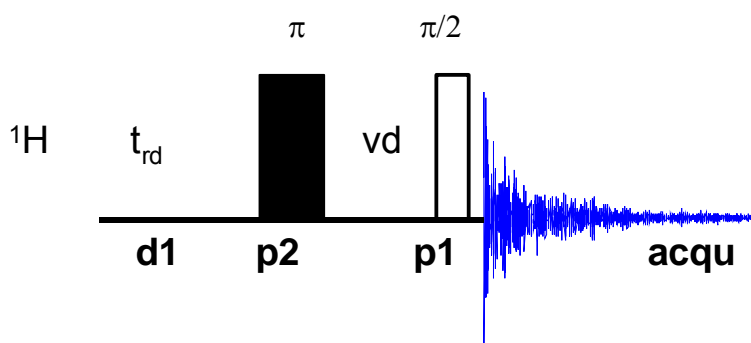
7.2.3 Optimization of the mixing time

The best mixing time **d8** is determined by the relaxation behavior of the molecule, which largely depends on the mobility of the molecule. The larger the molecule, the higher the viscosity of the solvent and the lower the temperature, the longer **d8** should be. However, **d8** also depends on the magnetic field.

Generally, spectra of rather small organic molecules are run with a mixing time of 600-900 ms, whereas only about 150 ms are used for large biomolecules. However, if you have no idea about the best time to use or poor spectra are yielded with these values, it may be worth to run an optimization experiment for **d8** in advance of the NOESY.


This can be done with an inversion recovery experiment. The pulse program is shown in Figure 7.2. In this experiment the magnetization is inverted with the first 180° pulse. After a certain delay **d7** a 90° read pulse is applied which brings back the z-magnetization into the x,y-plane and that way makes it observable. Phase and intensity of the observed signal will depend on the time we wait in between these 2 pulses. A zero intensity of the signals will be observed after $t_{null} = T_1 \times \ln(2)$. This time is adequate to guarantee a sufficient build up of the NOE.

Figure 7.2: Pulse sequence of the inversion recovery experiment



To run the experiment, it is best to start from a 1D proton data set.

- Create a new experiment with the command **edc** and read in the normal 1D proton parameter set by typing **rpar PROTON all** if you have not selected a parameter set yet.
- Type **getprosol** to read in the correct pulses.
- Set the number of scans to 1 (**ns 1**) and the number of dummy scans to 0 (**ds 0**).
- Adjust the receiver gain (**rga**), start the experiment (**zg**), process it (**ef**) and apply a phase correction (**apk**). Change the PH_mod to pk in the ProcPars to store the phase correction.
- Change the pulse program to an inversion recovery experiment by typing **pulprog t1ir1d** or by selecting this pulse program from the list in the AcqPars.
- Set **d7** to 10 ms (**d7 10m**) and start the experiment with **zg**.

- After the experiment fourier transform the spectrum with the command **efp**. The signals should all be negative.
- Now the adjustment of **d7** can be started. Type **gs** to get into an interactive data acquisition mode, where parameters can be changed, while the sample is continuously measured and displayed, so that the effect of the change can be judged directly. To see the phased spectrum click on the  button. Now you can interactively change **d7** either by typing in the command **d7** and giving it a value or with the sliders to the left of the spectral window. Steps of about 100 ms are appropriate. Note that the experiment is running in the background, so the effect of the change can only be seen after the next scan! The signals will get smaller with increasing **d7**, then they will go through zero intensity and finally to positive values. The mixing time we are looking for equals the delay that is needed for minimum signal intensity of all peaks. Note, that the signals will go through zero intensity at different times, as the relaxation behaviour depends on the mobility of the group the proton is bonded to. Hence a methyl group will have a longer relaxation time than a proton that is bonded to a rather rigid aromatic ring system. Furthermore, remember that there may be small molecules (solvent, TMS, etc.) giving rise to very slowly relaxing signals that don't belong to the molecule of interest.
- The value of **d7** giving minimum signal intensity is the appropriate value for **d8**. Note, that for macromolecules (proteins, polymers) the best value for **d8** may be shorter than the value found for **d7** to prevent spin diffusion.

7.3 Spectral processing

After the spectral acquisition has finished, the data has to be processed. You may do this either automatically using the **xaup** command or manually.

7.3.1 Automatic processing

The command **xaup** will invoke the automation AU program that is stored along with the processing parameters in the **aunmp** parameter. In this case the **aunmp** AU program is called **proc_2dsym**.

Typing **xaup** will automatically process the data and thus it will generate a phase corrected spectrum, it will also perform a baseline correction and it will do an automatic integration of the peaks. By default, a plot will be created using the plot-layout which is also stored in the processing parameters. For the NOESYPHSW parameter-set this layout file is called **2D_hom.xwp**.

7.3.2 Manual processing

The acquired data may also be processed manually. The steps that belong to the spectral processing are all arranged in the NMR data processing guide, which may be invoked from the **Processing → Data Processing Guide** menu.

Window function: In 2D experiments the window functions can be used to diminish truncation artefacts, to enhance wanted signals over unwanted (for example diagonal peaks) and to improve the peak shape.


As the number of acquired points in a 2D experiment must be kept rather low for time reasons and to avoid too much data, the recorded FID is heavily truncated. The same issue occurs in the indirect dimension, although here the effect is even bigger, as the number of increments defines the number of points here. To avoid truncation artefacts (wiggles) in the resulting spectrum, sine-functions are used in both dimensions to force the FID to go down to zero.


To set the window functions it is easiest to click on the tag ProcPars and go to the sub menu Window Functions. For the parameter WDW several functions can be chosen from the pull down menu. Use SINE for a normal sine bell function or QSIN for a squared sine bell function, which approaches the zero value at the end of the FID a little smoother, than the pure sine bell.


SSB is a value that determines, by how much the sine function is shifted. If it is set to 0, the maximum is in the beginning of the curve. If it is set to a value n , the sine bell is shifted by π/n . For a phase sensitive NOESY **ssb** should be set to 2 in both dimensions. If there are still some wiggles occurring after the fourier transformation. Try some other values for **ssb** (3 or 4) and see whether this improves the appearance of the spectrum.

Fourier transformation: After the application of the window function, the time domain data has to be Fourier transformed to yield a frequency domain spectrum. This is achieved with the command **xfb**.


Phase correction: After fourier transformation, the spectrum needs to be phased. There is an au-program that takes care of an automatic phase correction. It can be started with the command **calcphomo**. The program calculates the required values for a phase correction in F1 and F2. After this the data needs to be fourier transformed again to apply the calculated phase correction.

It is also possible to manually phase correct the spectrum. Click the phase correction button  or type **ph** and select **manual phasing** from the dialogue window. The window will now show the spectrum with a cursor cross and some icons on top. Now some rather strong peaks should be selected that are spread as far as possible over the spectral range. To do this move the mouse, until the cursor is over a peak, click the right mouse button and select **Add** from the menu. That way, the rows and columns along the cursor cross will be added to the rows and columns that will be shown when going to the phasing itself.


To adjust the phasing of the rows, click on the  button. The selected rows will be displayed as 1D spectra. The position of the reference- or pivot point is indicated by a red vertical line. By default, the highest peak of the first row is defined as the pivot point. However, this may be a peak which is located in the central part of the spectrum. If this is the case it is advisable to define a peak somewhere close to the edge of one of the rows as pivot point. Move the cursor over the peak, press the right mouse button and select **Set Pivot Point** from the context menu.


Use zero order phase correction to correct the phase around the area of the pivot point: place the cursor over the  button, hold down the left mouse button and move the mouse up or down. Thus, adjust the 0 order phase value until the baseline around the peak at the pivot point is flat and the


diagonal peak is phased negative. Note that the crosspeaks will then be positive for small molecules and negative for macromolecules.

Then adjust the first order phase value in the same way by holding down the left mouse button over the  button. Move the mouse up and down until a cross peak on the opposite side of the spectral region is phased and the baseline around this peak is flat as well.

Note that it may not be possible to phase all peaks into pure absorption, as they may be dephased as well in the indirect dimension. If this is the case, some peaks will contain a negative part. Therefore it may be more useful to look at the baseline, than just at the peaks phase.


By clicking the save-and-return button () , the phase correction will be applied to the spectrum and the values for zero- and first order phase correction will be stored to the corresponding processing parameters of the F2 dimension: **phc0** and **phc1**. Whenever you type **xfb** these phase correction values will be taken into account, as long as the PH_mod under the ProcPars is set to pk.

Now the spectrum may still be out of phase in the indirect dimension. Press the button  and proceed with the phasing of the columns exactly the same way, as with the rows. The resulting phase correction will then be automatically entered into the parameters **phc0** and **phc1** of the indirect dimension F1.

Leave the phasing by clicking the button .

Calibration and referencing: The chemical shift ppm axis may be calibrated. The **sref** command automatically looks for a peak at around 0ppm (± 0.5 ppm) and assumes that this is the TMS or another internal reference substance. It will then calibrate the axes of the spectrum in a way that this peak is at exactly 0ppm in both dimensions. If **sref** does not find a peak at around 0 ppm, it uses the solvent information for the axis calibration.

This method only works unambiguously if you have added TMS or another internal reference compound to your sample and if no peaks from your compound are in the area around 0ppm.

You may also use the manual mode to calibrate the spectrum. Zoom into a diagonal peak of interest, which you'd like to set to a certain ppm value (e.g. a strong signal whose chemical shift is known). To zoom into a certain region of a spectrum, hold down the left mouse button in the spectrum display and drag the cursor over the area of interest. Then click on this button  to enter the manual calibration mode.

Place the cross of the cursor over the center of the peak that you'd like to use for calibration and click the left mouse button. Enter the desired frequency for both dimensions into the calibration window that opens up. Click **OK** and you're taken back to the default display and the axis calibration is stored into the processing parameters as the **sr** parameter. This parameter is also adjusted by the **sref** command.

Baseline correction: The baseline of the spectrum may be corrected automatically. This has to be done separately for both dimensions. Type **abs2** and then **abs1**. This will perform the correction first in the F2 dimension and then in F1. The commands will apply a polynomial baseline correction

where the order of the polynomial function is defined by the processing parameter **absg**. The value of **absg** may range between 0 and 5. The default values of **absg** stored with the NOESYPHSW parameter set are 5 for both dimensions.

Automatic baseline correction may also be applied only for parts of the spectrum. The processing parameters **absf1** and **absf2**, which can be found under the ProcPars tag for both dimensions, define the left and the right limit of the spectral region (in ppm), where the baseline correction should be applied. Then use the command **absf1** and **absf2**, respectively to correct only the selected regions.

Symmetrization: To improve the spectral resolution in the indirect dimension and to suppress T₁-noise, homonuclear 2D spectra may be symmetrized.

Theoretically, a spectrum is symmetric along the diagonal peaks. However, as the spectra are usually recorded with more points in the direct than in the indirect dimension and due to artifacts, this is usually not exactly the case. The symmetrization algorithm checks the intensity of every spectral point and compares it with the intensity of the symmetry related point on the opposite side of the diagonal. The lower intensity is then taken for both. This leads to narrower peaks in the indirect dimension and to a reduction of artifacts and T₁-noise. However, if some intensity is found on both sides of the diagonal due to T₁-noise or other artifacts, symmetrization will produce something, that can hardly be distinguished from a real peak, due to the odd square shape that that even real peaks will have after symmetrization. So it is better to be conscious about problems that may result from symmetrization.

To symmetrize a NOESY type **symt** on the command line or select **Processing → Symmetrize / Tilt** from the menu. In the dialog box, choose the option “Symmetrize phase sensitive spectrum”. After clicking **OK** the symmetrization will be applied. The same kind of symmetrization is applied if you type in directly the command **syma**.

7.3.3 Processing parameters

The processing parameters may be displayed by selecting the ProcPars tag in the TopSpin display window or by typing **edp**. Some of these processing parameters govern certain processing commands and may be optimized before the application of the respective processing command. Each parameter may also be accessed by typing it's name in lower case letters.

Table 7.2: Processing parameters that may be adjusted from the default parameter-set

F2 Parameters		
Parameter	Explanation	Comments and possible values
SI	Size of the real spectrum	This corresponds to TD in the acquisition parameters. si defines the number of real data points that are used for the processing. If the value for si is larger than ½ td , zero filling is applied since td is given in complex numbers. Zero filling

		smoothes spectra, so usually si = td . If si < ½ td , then some of the acquired data points are not taken into account!
SR	Spectral reference	This parameter is altered by the spectral referencing. It is 0 if no axis referencing is performed.
WDW	Type of the window function	This parameter defines, which type of a window function will be applied in the direct dimension. Choose SINE or QSINE
SSB	Shifted sine bell	ssb determines where the maximum of the applied sine bell window function is. Set it to 2 for phase sensitive spectra.
PH_mod	Phase correction mode	This must be set to pk. The phase values of ph0 and ph1 will then automatically be applied in all proceeding fourier transformations.
ABSG	order of the polynomial for abs	$0 \leq \mathbf{absg} \leq 5$. Usually absg = 5 works for most spectra.
BC_mod	Baseline correction on the FID	This value determines the polynomial order of the baseline correction that is performed on the FID. Set it to quad.

F2 Parameters

Parameter	Explanation	Comments and possible values
SI	Size of the real spectrum	If the value for si is larger than ½ td , zero filling is applied on phase sensitive spectra since td is given in complex numbers. Zero filling smoothes spectra, so usually si = td . If si < ½ td , then some of the acquired data points are not taken into account!
SF	Spectral reference	This parameter is altered by the spectral referencing. It is 0 if no axis referencing is performed.
WDW	Type of the window function	This parameter defines, which type of a window function will be applied in the direct dimension. Choose SINE or QSINE
SSB	Shifted sine bell	ssb determines where the maximum of the applied sine bell window

		function is. Set it to 2 for phase sensitive spectra.
PH_mod	Phase correction mode	This must be set to pk. The phase values of ph0 and ph1 will then automatically be applied in all proceeding fourier transformations.
MC2	Type of fourier transformation	The value of mc2 depends on the FnMODE that was chosen during acquisition. Set it to States, TPPI or States-TPPI, respectively.

7.4 Post-processing

After the spectra are processed (Fourier transformed, referenced and baseline corrected), peaks may be picked and the spectrum may be plotted for further interpretation.

7.4.1 Peak picking

There are different options on how to perform peak picking.

In order to display the picked peaks, right click in the spectrum display window and select “display properties” from the context menu and tick the box “Peak labels”.

The picked peaks are stored in a peak list text file which may be displayed by selecting the “Peaks” tag in the main window. The peak list is interactive and you may correlate it with the spectrum and display spectrum and peak list at the same time. Right click in the peak list table and select “show spectrum” → “in correlated window” from the context menu. If you now move the mouse cursor over any entry in the list, the cursor in the spectrum will automatically jump to the corresponding peak in the spectrum. The peak list may also be exported as a text file or peak list file. Right click in the peak list window and select the “export” option from the context menu.

Automatic peak picking on the displayed region: To start the peak picking dialog window, type in the command **pp**.

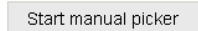


You have the option to append the data to a presumably already existing list. If this is not checked, the procedure will create a completely new peak list. If it is checked it may be wise to skip already existing peaks within that list, this means: not entering it a second time to the existing peaks.

The parameters that can be set include the region. Click on the “Set to” button. Here you can choose, whether you want to peak pick the complete processed spectral range, only the displayed region, the region that is defined by the F1/F2 parameters (which can be adjusted with the command **f1p** and **f2p**, respectively) or the region that was chosen during the last peak picking routine. Of course you can also type in the desired values directly in the peak picking dialog window. Note that the whole region can also be peak picked without opening the graphical interface with the command **ppf**,

whereas only the region defined by **f1p** and **f2p** is used when the command **pps** was applied.

The sensitivity can be altered in several ways. First a lower limit for the smallest intensity that should be recognized as a peak can be entered. You can type in any value for MI or go to the “Set to” button and choose either the lowest contour level, the MI value already stored with the dataset or the MI value used during the last peak picking routine. If the value is too low, too many peaks will be picked, if it is set to a too high value, weak peaks will be missed. A similar limitation can be applied to the maximum intensity. If MAXI is set to a smaller value than 1, every peak that has a higher intensity will not be picked. The diagonal gap allows to define a certain number of points around the diagonal, that will not be considered during peak picking. That way the diagonal peaks of homonuclear spectra will not be entered in the peak list. The smaller the resolution value is, the closer 2 peaks may be to be still considered as 2 separate peaks.

For a NOESY positive and negative peaks need to be detected.

Manual peak picking: The manual peak picking mode can be started either from the peak picking dialog box by pressing the button  or directly from the main TopSpin window by clicking on the icon . You will enter the peak picking window. Set the cursor over a peak, click with the right mouse button and confirm, that the peak should be added to the peak list. To delete a peak, right click on an already marked peak and click on “Delete Peak From List”. If you click on “Annotate Peak” it is possible to add any desired assignment to the peak. Leave the dialog with the  button.

7.4.2 Projections

It is possible to show 1D spectra on either side of the 2D plot. This may be helpful, to identify cross peaks within spectrum. To toggle the display of the projections on, right click on the 2D spectrum and select the “Display Properties...”. In the dialog window toggle on the option “Show projections”. On the bottom it is possible to choose, whether the projections in F1, in F2 or in both dimensions should be visible. The moment, the projection display is turned on the positive projections are displayed above the spectrum and to the left as a default.

Display of a recorded 1D proton spectrum: Right click with the mouse over the displayed projection and choose the option “External projection”. A dialog box will open where you can type in the path information of the dataset that should be displayed.

Alternatively it is possible to start a projection display dialog box with the command **projd**. On top the option “Display 1D spectra along with the 2D spectrum” should be toggled on. If the checkbox is ticked it is possible to enter any 1D dataset for the F2 (left) and the F1 (right) dimension, respectively. After clicking **OK** the spectra will be displayed.

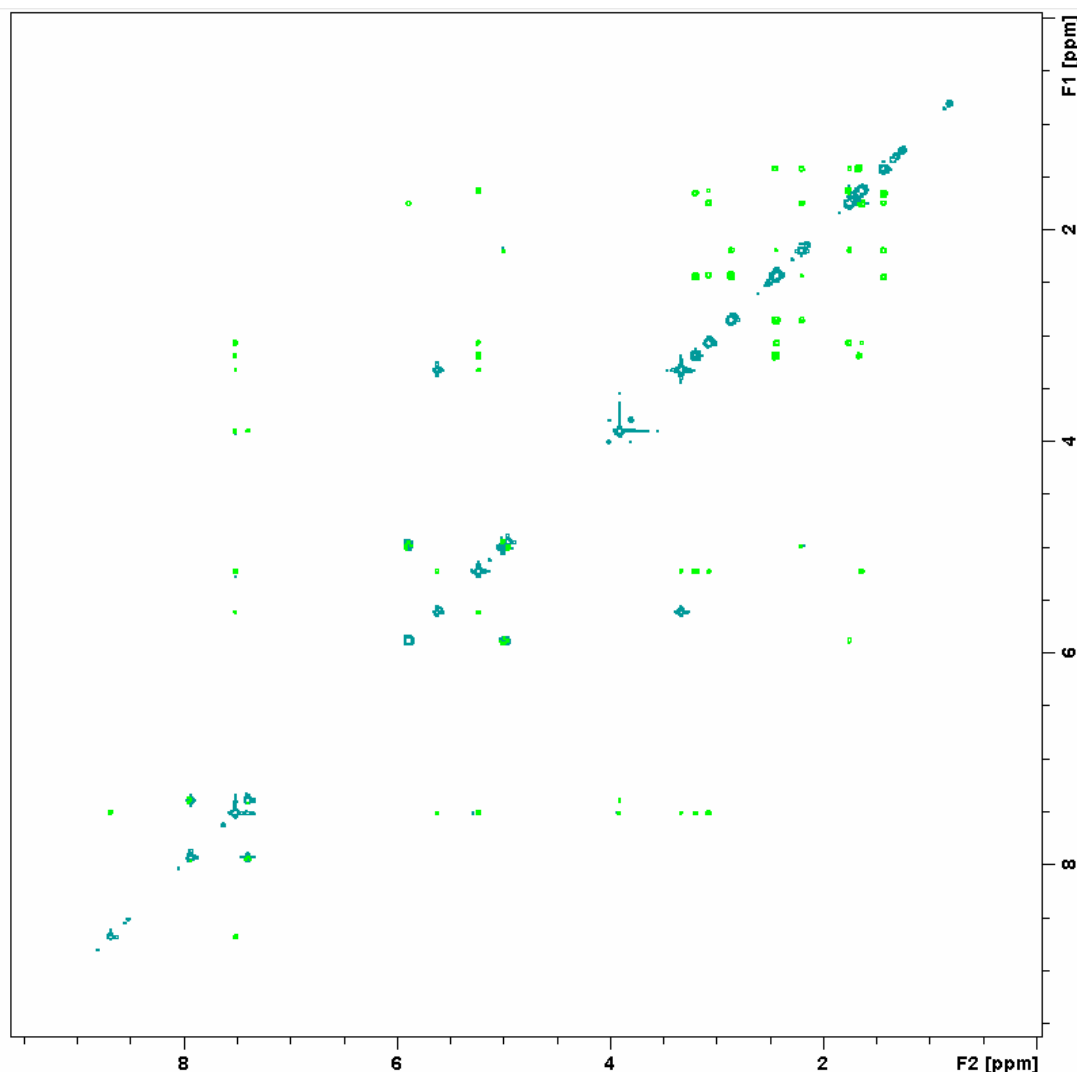
Display of internal projections: To switch back to the internal projections, right click over the projections and choose the option “Internal Projection”. The positive internal projection will be displayed again.

Alternatively it is again possible to use the command **projd** and toggle on the option “Display projections along with the 2D spectrum” on the top. After clicking **OK** the internal positive projections will be displayed.

7.5 Spectra interpretation

A NOESY spectrum of 50 mM Quinine in DMSO is shown in Figure 7.3.

Figure 7.3: NOESY of 50 mM Quinine in DMSO.



Constitution and molecular structure: In contrast to a COSY spectrum that correlates only scalarly coupled protons, a NOESY will show cross peaks in between protons that are spatially close to each other.

The sign of the cross peaks depends on the size of the molecule. If the diagonal was phased negative, cross peaks will be positive for small molecules and negative for large ones. However, negative peaks can also result from exchange phenomena!

The intensity of the cross peaks depends on the distance of the protons! Hence an accurate integration of the signals can yield quantitative information about through space distances within a given molecule. The

intensity of the individual cross signals goes down with d^6 , where d is the distance of the protons. Therefore not only structural bonding information is available, but also the 3 dimensional structure can be retrieved from a NOESY.

7.6 Possible pitfalls

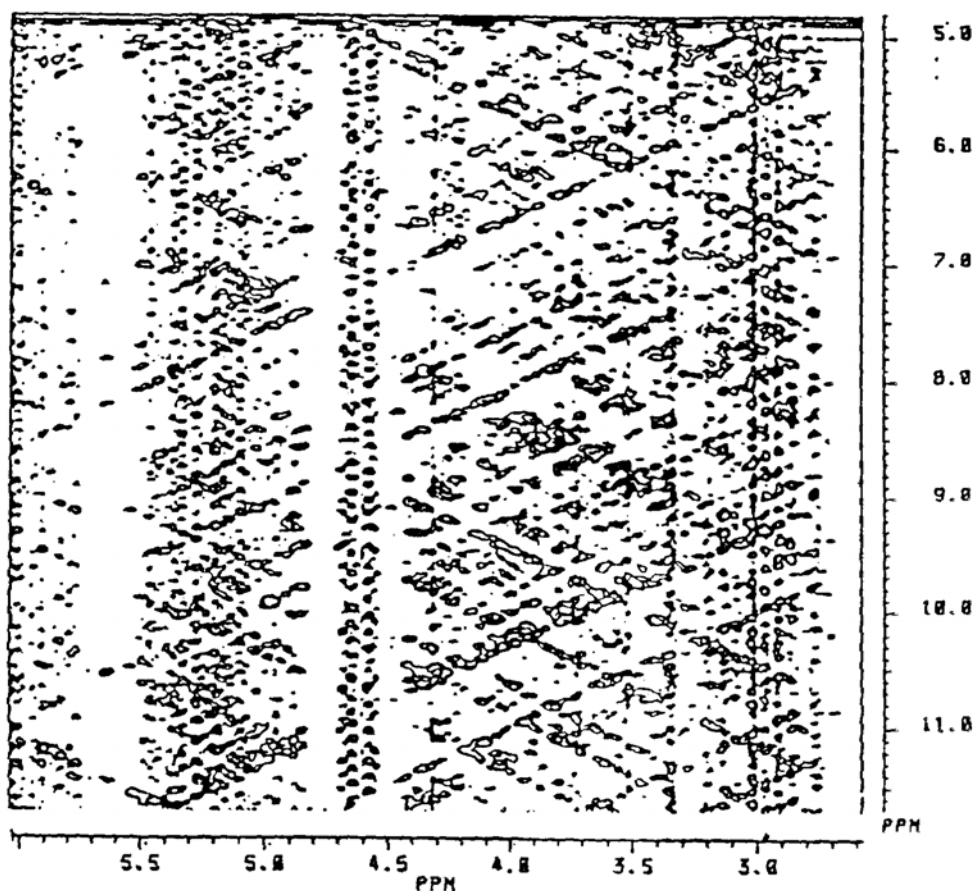
Using the standard parameter set, which is called up by typing **rpar NOESYPHSW all** and **getprosol** (see the chapter on data acquisition), will mostly lead to satisfactory spectra without the need to change parameters.

Some basic issues (lineshape, sample concentration and shim) should be checked already in the preparatory 1D proton experiment (see chapter 2)

However some common pitfalls and artefacts that may lead to unsatisfactory results are described here. We describe the most commonly observed phenomena and the causes as well as solutions to these relatively common things.

- For 2D experiments, spinning should always be turned off, as the spinning may introduce artefacts leading to criss cross noise in the spectra (Figure 7.4). Note that you have to adjust the z and eventually also the z^2 shim, if you stop sample rotation. Therefore it is best to run already the preparatory 1D experiment without spinning.

Figure 7.4: Heavy criss cross noise in a NOESY due to sample spinning.



- Note that the sign of the cross signals in a NOESY depends on the mobility of the observed proton and the magnetic field. Not only positive and negative signals can be observed, there is also a zero crossing of the signal intensity somewhere. If that is the case, there is no chance to get any reasonable NOESY spectrum out of the given setup. However, the viscosity of the solvent can be influenced by changing the solvent or the temperature or it may be possible to run the spectrum at a different magnetic field. Usually running a ROESY instead of a NOESY will however be the most practicable solution (see chapter 8).
- The number of scans and dummy scans needs to be a multiple of the minimum given in the pulse program. If that is not the case, the phase cycle is not completed which may lead to auxiliary diagonals parallel to the real diagonal (Figure 6.4).
- Miscalibration of chemical shifts by up to 0.5ppm: This happens sometimes in the automation – either in IconNMR or using the **xaup** command – if no internal standard has been added. The reason is that the **sref** command finds a very small peak (possibly noise) close to 0ppm. It assumes that this is TMS and sets it to 0ppm. You may undo this by setting **sr** to 0Hz.

8 The ROESY Experiment

8.1 General information about the experiment

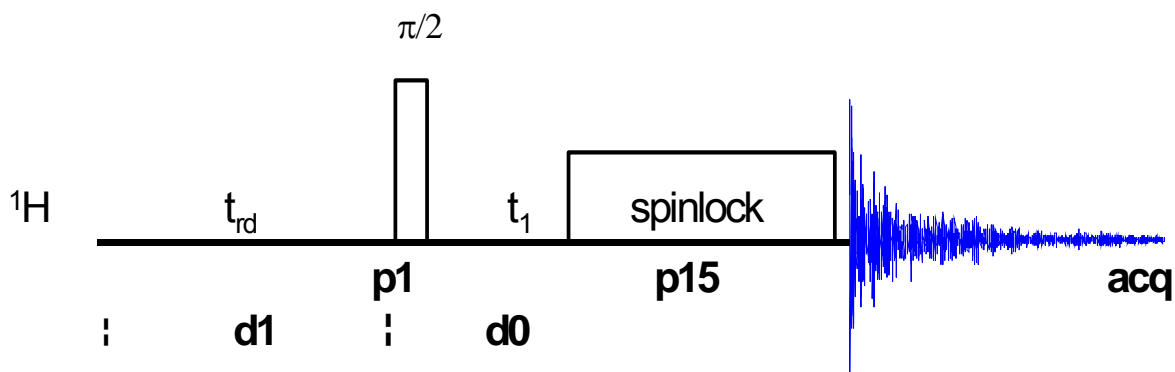
Whereas a COSY generally correlates protons via geminal or vicinal scalar spin couplings, a ROESY shows correlations of protons, that are spatially close, no matter whether they are as well close through bonds and therefore scalarly coupled or not. The interaction that is important for an ROE (Rotational Overhauser Effect) transfer is the so called dipolar coupling, which can only be directly observed in solid or partially oriented phases. However, the ROE also leads to an intensity change of a signal, if the signal of a coupled proton is saturated. This effect is based on the relaxation behaviour. In contrast to a NOESY the magnetization transfer in a ROESY takes place during a spin lock sequence. Therefore the behaviour corresponds to an NOE transfer at a very low magnetic field – the B1 field. As the question, whether a signal increase or decrease occurs during the NOE transfer is governed also by the magnetic field, this results in an increase of all signals, no matter how large the molecule and how viscous the solvent is. Hence a ROESY experiment is a very good option, if the NOESY hardly shows any cross signals due to an unfortunate combination of the molecules mobility and the magnetic field strength.

8.1.1 Pulse sequence and a few NMR details

ROESY (Rotating-frame Overhauser Effect Spectroscopy) is an experiment in which homonuclear Nuclear Overhauser effects (NOEs) are measured under spin-locked conditions. ROESY is especially suited for molecules with motional correlation times (τ_c) such that $\omega\tau_c \sim 1$, where ω is the angular frequency $\omega = \gamma B$. In such cases the laboratory-frame NOE is nearly zero, but the rotating-frame NOE (or ROE) is always positive and increases monotonically for increasing values of τ_c . In ROESY the mixing time is the spin-lock period during which spin exchange occurs among spin-locked magnetization components of different nuclei (recall that spin exchange in NOESY occurs while magnetization is aligned along the z axis). Different spectral density functions are relevant for ROESY than for NOESY and these cause the ROE to be positive for all values of τ_c .

ROESY spectra can be obtained in 2D absorption mode. This is also useful for the identification of certain artifacts. Spurious cross peaks, both COSY-type and TOCSY-type, can be observed due to coherence transfer between scalar coupled spins. COSY-type artifacts (anti-phase) arise when the mixing pulse transfers anti-phase magnetization from one spin to another. TOCSY-type artifacts (which have the same phase as the diagonal peaks, while ROESY cross peaks have opposite phase) arise when the Hartmann-Hahn condition is met (e.g., when spins A and B have opposite but equal offsets from the transmitter frequency or when they have nearly identical chemical shifts). In general, to minimize these artifacts, it is suggested to limit the strength of the spin-locking field.

Figure 8.1: ROESY Pulse Sequence



8.2 Preparation and Acquisition

The steps that belong to the spectral acquisition are all arranged in the NMR spectra acquisition guide, which may be invoked from the **Acquisition** → **Data Acquisition Guide** menu.

8.2.1 Data acquisition step by step

- Make sure that the sample tube is properly adjusted in the spinner if needed and insert it into the magnet. (For more information on sample preparation and handling, please refer to chapter 1.3).
- If needed, make a new dataset, type **edc** or **new** or select **File** → **New** from the menu.

Here, the dataset name, the experiment number (**EXPNO**), the processing number (**PROCNO**), the directory and the user name are entered. All of these entries will become directories on the respective hard-disk. (For more information on directory structures, refer to chapter 1.3).

You may also choose the correct solvent in the **Solvent** field and select a parameter-set here in the **Experiment** field. The experimental parameters for acquisition, processing, plotting and output will be loaded from the selected parameter-set as if you would have typed **rpar**. You may also give a title.

- Lock the sample by typing **lock** and select the correct solvent.
- Match and tune the sample either manually by typing **wobb** and physically adjusting the matching and tuning sliders or screws on the probe – if you do not have an ATM probe – or automatically by typing **atma** – if you do have an ATM probe.
- Shim the sample either manually or by using the gradient shimming automation routine, type **gradshimau**.
- If you have not selected a parameter set yet (see above), type **rpar PROTON all**. This will select the 1D PROTON standard parameters. (For more information on parameter-sets, refer to chapter 1.3.)

- Type **getprosol** and run a preparatory 1D proton experiment to judge spectra quality and to get a reference for sweep width and transmitter offset (see chapter 2).
- Increase the experiment number in the same experiment set by typing **edc** and changing experiment number and eventually the parameter set to ROESYPHSW. You can also type in the command **iexpno** instead. This will just increase the experiment number by 1.
- If you have not selected a parameter set yet (see above), type **rpar ROESYPHSW all**. This will select the ROESY standard parameters, which may be used as they are or which may be adjusted to your needs later. (For more information on parameter-sets, refer to chapter 1.3)
- Type **getprosol** to load the probe dependent parameters!
- Type in the command **edc2** to define the reference proton spectrum. Enter the correct experiment and processing number in the according field of data set 2.

	Data Set 2	Data Set 3
NAME =	Quinine	Quinine
EXPNO =	1	1
PROCNO =	1	1
DIR =	C:\u	C:\u
USER =	los	los

- Adjust acquisition parameters or start the acquisition. We recommend that you use the automation mode by typing **xaua**. You may also start the receiver gain adjustment manually (type **rga**) and then start the acquisition and type **zg**.

8.2.2 Important acquisition parameters for this experiment

There are some acquisition parameters that may be modified for this experiment. The values of the parameters may be edited by clicking the AcqPars tag in the main window. You may access the full set of all acquisition parameters also by typing **eda** or a reduced set, where only parameters are displayed that are relevant for the selected pulse program by typing **ased**. Each parameter may also be accessed by typing its name in lower case letters.

In contrast to the 1D experiments there are 2 columns visible in the acquisition parameter editor now. The first column belongs to the direct or F2 dimension, the second one to the indirect or F1 dimension. Note that for homonuclear experiments, the nucleus in both dimensions and hence also the sweep width and the offset are the same.

Table 8.1: Acquisition parameters that may be adjusted from the default parameter-set

F2 Parameters		
Parameter	Explanation	Comments and possible values
PULPROG	pulse program for the acquisition	Use the roesyph pulse program which yields a phase sensitive standard ROESY.
NS	number of scans	The minimum number of scans is 8. You can use any multiple of 8 to yield a more intense signal, however the experiment lasts longer then.
DS	dummy scans	Use 16 or better even 32 dummy scans. The rather long lasting spin lock pulse will slightly heat the sample. The real experiment should not be started, before a temperature equilibrium is reached again.
TD, AQ	time-domain, acquisition time	These 2 values depend on each other. To avoid too much data td in F2 is generally set to 2k.
SW	spectral width	sw (in ppm, or correspondingly swh in Hz) defines the width of the spectral window and it has to be large enough to incorporate all peaks of the spectrum. Typically a 1D proton experiment is run in advance of the ROESY. Choose the whole range where signals are visible plus one additional ppm to either side. If you run a 1D proton spectrum in advance, define it as a reference with edc2 and start the acquisition with xaua , an automatic sweep range adjustment will be done.
O1P	transmitter offset	o1p (in ppm or o1 in Hz or sfo1 in MHz) defines the center of the spectral window (sw or swh). The signals should be centered around this value. If you run a 1D proton spectrum in advance, define it as reference with edc2 and start the acquisition with xaua , an automatic offset adjustment will be done.
D1	recycling delay between two scans	To save time, d1 is set to about $1.25 \cdot T1$. For most molecules, 1.5-2 s is an appropriate value.
RG	receiver gain	This is automatically adjusted using the

		commands xaua or rga .
P1, PL1	probe dependant pulse length and high power level	These parameters are dependant on the individual probe and are loaded by the getprosol command. p1 defines the length of the 90° pulse at the power level p11 .
P15, PL11	spin lock pulse length and probe dependant power	P15 determines the duration of the mixing time. 200 ms is the standard value for P15 . However, like the mixing time of the NOESY the best value for P15 depends on the relaxation behaviour of the molecule under investigation. A good rule of thumb is to take about $\frac{1}{2} - 1 \times T_1$. To determine T_1 a preliminary inversion recovery experiment can be done.
F1 Parameters		
Parameter	Explanation	Comments and possible values
TD	number of experiments	This value determines how many points are recorded in the indirect dimension. 256 is an appropriate value.
FnMODE	determines quadrature detection in F1	For phase sensitive spectra you can choose States, TPPI or States-TPPI as quadrature detection method.
ND_010	number of incremented delays	1. There is only one incremented delay in the experiment.
SW	sweep width	For homonuclear experiments this is the same value as in F2
NUC1	nucleus in F1	For homonuclear experiments this is the same as in F2. Select ^1H here.

8.2.3 Optimization of the mixing time

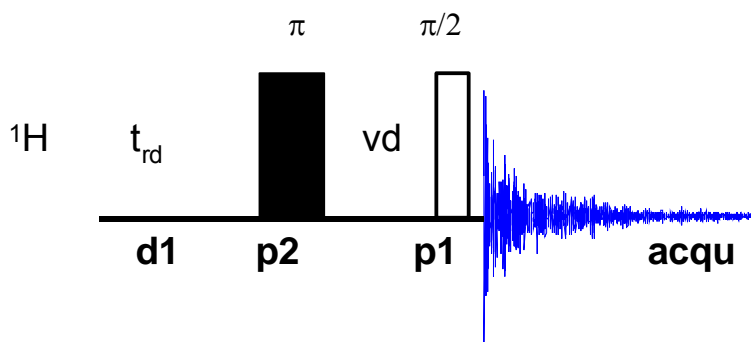
The best mixing time **p15** is determined by the relaxation behavior of the molecule, which largely depends on the mobility of the molecule. The larger the molecule, the higher the viscosity of the solvent and the lower the temperature, the longer **p15** should be. However, **p15** also depends on the magnetic field.

Generally, spectra of very small organic molecules (molecular mass < 400) are run with a mixing time of 300-600 ms, whereas only about 200 - 300 ms are used for molecules of 400 – 2000 u. However, if you have no idea about the best time to use or poor spectra are yielded with these values, it may be worth to run an optimization experiment for **p15** in advance of the ROESY.


This can be done with an inversion recovery experiment. The pulse program is shown in Figure 8.2. In this experiment the magnetization is inverted with

the first 180° pulse. After a certain delay **d7** a 90° read pulse is applied which brings back the z-magnetization into the x,y-plane and that way makes it observable. Phase and intensity of the observed signal will depend on the time we wait in between these 2 pulses. A zero intensity of the signals will be observed after $t_{null} = T_1 \times \ln(2)$. This time is adequate to guarantee a sufficient build up of the ROE.

Figure 8.2: pulse sequence of the inversion recovery experiment.



To run the experiment, it is best to start from a 1D proton data set.

- Create a new experiment with the command **edc** and read in the normal 1D proton parameter set by typing **rpar PROTON all** if you have not selected a parameter set yet.
- Type **getprosol** to read in the correct pulses.
- Set the number of scans to 1 (**ns 1**) and the number of dummy scans to 0 (**ds 0**).
- Adjust the receiver gain (**rga**), start the experiment (**zg**), process it (**ef**) and apply a phase correction (**apk**). Change the PH_mod to pk in the ProcPars to store the phase correction.
- Change the pulse program to an inversion recovery experiment by typing **pulprog t1ir1d** or by selecting this pulse program from the list in the AcquiPars.
- Set **d7** to 10 ms (**d7 10m**) and start the experiment with **zg**.
- After the experiment fourier transform the spectrum with the command **efp**. The signals should all be negative.
- Now the adjustment of **d7** can be started. Type **gs** to get into an interactive data acquisition mode, where parameters can be changed, while the sample is continuously measured and displayed, so that the effect of the change can be judged directly. To see the phased spectrum click on the  button. Now you can interactively change **d7** either by typing in the command **d7** and giving it a value or with the sliders to the left of the spectral window. Steps of about 100 ms are appropriate. Note that the experiment is running in the background, so the effect of the change can only be seen after the next scan! The signals will get smaller with increasing **d7**, then they will go through zero intensity and finally to positive values. The mixing time we are looking for equals the delay that

is needed for minimum signal intensity of all peaks. Note, that the signals will go through zero intensity at different times, as the relaxation behaviour depends on the mobility of the group the proton is bonded to. Hence a methyl group will have a longer relaxation time than a proton that is bonded to a rather rigid aromatic ring system. Furthermore, remember that there may be small molecules (solvent, TMS, etc.) giving rise to very slowly relaxing signals that don't belong to the molecule of interest.

- The value of **d7** giving minimum signal intensity is the appropriate value for **p15**.

8.3 Spectral processing

After the spectral acquisition has finished, the data has to be processed. You may do this either automatically using the **xaup** command or manually.

8.3.1 Automatic processing

The command **xaup** will invoke the automation AU program that is stored along with the processing parameters in the **aunmp** parameter. In this case the **aunmp** AU program is called **proc_2dsym**.

Typing **xaup** will automatically process the data and thus it will generate a phase corrected spectrum, it will also perform a baseline correction and it will do an automatic integration of the peaks. By default, a plot will be created using the plot-layout which is also stored in the processing parameters. For the ROESYPHSW parameter-set this layout file is called **2D_hom.xwp**.

8.3.2 Manual processing

The acquired data may also be processed manually. The steps that belong to the spectral processing are all arranged in the NMR data processing guide, which may be invoked from the **Processing → Data Processing Guide** menu.

Window function: In 2D experiments the window functions can be used to diminish truncation artefacts, to enhance wanted signals over unwanted (for example diagonal peaks) and to improve the peak shape.

As the number of acquired points in a 2D experiment must be kept rather low for time reasons and to avoid too much data, the recorded FID is heavily truncated. The same issue occurs in the indirect dimension, although here the effect is even bigger, as the number of increments defines the number of points here. To avoid truncation artefacts (wiggles) in the resulting spectrum, sine-functions are used in both dimensions to force the FID to go down to zero.


To set the window functions it is easiest to click on the tag ProcPars and go to the sub menu Window Functions. For the parameter WDW several functions can be chosen from the pull down menu. Use SINE for a normal sine bell function or QSIN for a squared sine bell function, which approaches the zero value at the end of the FID a little smoother, than the pure sine bell.


SSB is a value that determines, by how much the sine function is shifted. If it is set to 0, the maximum is in the beginning of the curve. If it is set to a value


n, the sine bell is shifted by π/n . For a phase sensitive ROESY **ssb** should be set to 2 in both dimensions. If there are still some wiggles occurring after the fourier transformation. Try some other values for **ssb** (3 or 4) and see whether this improves the appearance of the spectrum.


Fourier transformation: After the application of the window function, the time domain data has to be Fourier transformed to yield a frequency domain spectrum. This is achieved with the command **xfb**.

Phase correction: After fourier transformation, the spectrum needs to be phased. There is an au-program that takes care of an automatic phase correction. It can be started with the command **calcphhomo**. The program calculates the required values for a phase correction in F1 and F2. After this the data needs to be fourier transformed again to apply the calculated phase correction.


It is also possible to manually phase correct the spectrum. Click the phase correction button  or type **ph** and select **manual phasing** from the dialogue window. The window will now show the spectrum with a cursor cross and some icons on top. Now some rather strong peaks should be selected that are spread as far as possible over the spectral range. To do this move the mouse, until the cursor is over a peak, click the right mouse button and select **Add** from the menu. That way, the rows and columns along the cursor cross will be added to the rows and columns that will be shown when going to the phasing itself.

To adjust the phasing of the rows, click on the  button. The selected rows will be displayed as 1D spectra. The position of the reference- or pivot point is indicated by a red vertical line. By default, the highest peak of the first row is defined as the pivot point. However, this may be a peak which is located in the central part of the spectrum. If this is the case it is advisable to define a peak somewhere close to the edge of one of the rows as pivot point. Move the cursor over the peak, press the right mouse button and select **Set Pivot Point** from the context menu.


Use zero order phase correction to correct the phase around the area of the pivot point: place the cursor over the  button, hold down the left mouse button and move the mouse up or down. Thus, adjust the 0 order phase value until the baseline around the peak at the pivot point is flat and the diagonal peak is phased negative. Note that the crosspeaks will then be positive.


Then adjust the first order phase value in the same way by holding down the left mouse button over the  button. Move the mouse up and down until a cross peak on the opposite side of the spectral region is phased and the baseline around this peak is flat as well.

Note that it may not be possible to phase all peaks into pure absorption, as they may be dephased as well in the indirect dimension. If this is the case, some peaks will contain a negative part. Therefore it may be more useful to look at the baseline, than just at the peaks phase.

By clicking the save-and-return button () , the phase correction will be applied to the spectrum and the values for zero- and first order phase correction will be stored to the corresponding processing parameters of the F2 dimension: **phc0** and **phc1**. Whenever you type **xfb** these phase


correction values will be taken into account, as long as the PH_mod under the ProcPars is set to pk.

Now the spectrum may still be out of phase in the indirect dimension. Press the button  and proceed with the phasing of the columns exactly the same way, as with the rows. The resulting phase correction will then be automatically entered into the parameters **phc0** and **phc1** of the indirect dimension F1.

Leave the phasing by clicking the button .

Calibration and referencing: The chemical shift ppm axis may be calibrated. The **sref** command automatically looks for a peak at around 0ppm (± 0.5 ppm) and assumes that this is the TMS or another internal reference substance. It will then calibrate the axes of the spectrum in a way that this peak is at exactly 0ppm in both dimensions. If **sref** does not find a peak at around 0 ppm, it uses the solvent information for the axis calibration.

This method only works unambiguously if you have added TMS or another internal reference compound to your sample and if no peaks from your compound are in the area around 0ppm.

You may also use the manual mode to calibrate the spectrum. Zoom into a diagonal peak of interest, which you'd like to set to a certain ppm value (e.g. a strong signal whose chemical shift is known). To zoom into a certain region of a spectrum, hold down the left mouse button in the spectrum display and drag the cursor over the area of interest. Then click on this button  to enter the manual calibration mode.

Place the cross of the cursor over the center of the peak that you'd like to use for calibration and click the left mouse button. Enter the desired frequency for both dimensions into the calibration window that opens up. Click **OK** and you're taken back to the default display and the axis calibration is stored into the processing parameters as the **sr** parameter. This parameter is also adjusted by the **sref** command.

Baseline correction: The baseline of the spectrum may be corrected automatically. This has to be done separately for both dimensions. Type **abs2** and then **abs1**. This will perform the correction first in the F2 dimension and then in F1. The commands will apply a polynomial baseline correction where the order of the polynomial function is defined by the processing parameter **absg**. The value of **absg** may range between 0 and 5. The default values of **absg** stored with the ROESYPHSW parameter set are 5 for both dimensions.

Automatic baseline correction may also be applied only for parts of the spectrum. The processing parameters **absf1** and **absf2**, which can be found under the ProcPars tag for both dimensions, define the left and the right limit of the spectral region (in ppm), where the baseline correction should be applied. Then use the command **absf1** and **absf2**, respectively to correct only the selected regions.

Symmetrization: To improve the spectral resolution in the indirect dimension and to suppress T_1 -noise, homonuclear 2D spectra may be symmetrized.

Theoretically, a spectrum is symmetric along the diagonal peaks. However, as the spectra are usually recorded with more points in the direct than in the

indirect dimension and due to artifacts, this is usually not exactly the case. The symmetrization algorithm checks the intensity of every spectral point and compares it with the intensity of the symmetry related point on the opposite side of the diagonal. The lower intensity is then taken for both. This leads to narrower peaks in the indirect dimension and to a reduction of artifacts and T_1 -noise. However, if some intensity is found on both sides of the diagonal due to T_1 -noise or other artifacts, symmetrization will produce something, that can hardly be distinguished from a real peak, due to the odd square shape that that even real peaks will have after symmetrization. So it is better to be conscious about problems that may result from symmetrization.

To symmetrize a ROESY type **symt** on the command line or select **Processing → Symmetrize / Tilt** from the menu. In the dialog box, choose the option “Symmetrize phase sensitive spectrum”. After clicking **OK** the symmetrization will be applied. The same kind of symmetrization is applied if you type in directly the command **syma**.

8.3.3 Processing parameters

The processing parameters may be displayed by selecting the ProcPars tag in the TopSpin display window or by typing **edp**. Some of these processing parameters govern certain processing commands and may be optimized before the application of the respective processing command. Each parameter may also be accessed by typing it's name in lower case letters.

Table 8.2: Processing parameters that may be adjusted from the default parameter-set

F2 Parameters		
Parameter	Explanation	Comments and possible values
SI	Size of the real spectrum	This corresponds to TD in the acquisition parameters. si defines the number of real data points that are used for the processing. If the value for si is larger than $\frac{1}{2}$ td , zero filling is applied since td is given in complex numbers. Zero filling smoothes spectra, so usually si = td . If si < $\frac{1}{2}$ td , then some of the acquired data points are not taken into account!
SR	Spectral reference	This parameter is altered by the spectral referencing. It is 0 if no axis referencing is performed.
WDW	Type of the window function	This parameter defines, which type of a window function will be applied in the direct dimension. Choose SINE or QSINE
SSB	Shifted sine bell	ssb determines where the maximum of the applied sine bell window function is. Set it to 2 for phase

		sensitive spectra.
PH_mod	Phase correction mode	This must be set to pk. The phase values of ph0 and ph1 will then automatically be applied in all proceeding fourier transformations.
ABSG	order of the polynomial for abs	$0 \leq \mathbf{absg} \leq 5$. Usually absg = 5 works for most spectra.
BC_mod	Baseline correction on the FID	This value determines the polynomial order of the baseline correction that is performed on the FID. Set it to quad.

F2 Parameters

Parameter	Explanation	Comments and possible values
SI	Size of the real spectrum	If the value for si is larger then $\frac{1}{2} \mathbf{td}$, zero filling is applied on phase sensitive spectra since td is given in complex numbers. Zero filling smoothes spectra, so usually si = td . If si < $\frac{1}{2} \mathbf{td}$, then some of the acquired data points are not taken into account!
SF	Spectral reference	This parameter is altered by the spectral referencing. It is 0 if no axis referencing is performed.
WDW	Type of the window function	This parameter defines, which type of a window function will be applied in the direct dimension. Choose SINE or QSINE
SSB	Shifted sine bell	ssb determines where the maximum of the applied sine bell window function is. Set it to 2 for phase sensitive spectra.
PH_mod	Phase correction mode	This must be set to pk. The phase values of ph0 and ph1 will then automatically be applied in all proceeding fourier transformations.
MC2	Type of fourier transformation	The value of mc2 depends on the FnMODE that was chosen during acquisition. Set it to States, TPPI or States-TPPI, respectively.

8.4 Post-processing

After the spectra are processed (Fourier transformed, referenced and baseline corrected), peaks may be picked and the spectrum may be plotted for further interpretation.

8.4.1 Peak picking

There are different options on how to perform peak picking.

In order to display the picked peaks, right click in the spectrum display window and select “display properties” from the context menu and tick the box “Peak labels”.

The picked peaks are stored in a peak list text file which may be displayed by selecting the “Peaks” tag in the main window. The peak list is interactive and you may correlate it with the spectrum and display spectrum and peak list at the same time. Right click in the peak list table and select “show spectrum” → “in correlated window” from the context menu. If you now move the mouse cursor over any entry in the list, the cursor in the spectrum will automatically jump to the corresponding peak in the spectrum. The peak list may also be exported as a text file or peak list file. Right click in the peak list window and select the “export” option from the context menu.

Automatic peak picking on the displayed region: To start the peak picking dialog window, type in the command **pp**.




You have the option to append the data to a presumably already existing list. If this is not checked, the procedure will create a completely new peak list. If it is checked it may be wise to skip already existing peaks within that list, this means: not entering it a second time to the existing peaks.

The parameters that can be set include the region. Click on the “Set to” button. Here you can choose, whether you want to peak pick the complete processed spectral range, only the displayed region, the region that is defined by the F1/F2 parameters (which can be adjusted with the command **f1p** and **f2p**, respectively) or the region that was chosen during the last peak picking routine. Of course you can also type in the desired values directly in the peak picking dialog window. Note that the whole region can also be peak picked without opening the graphical interface with the command **ppf**, whereas only the region defined by **f1p** and **f2p** is used when the command **pps** was applied.

The sensitivity can be altered in several ways. First a lower limit for the smallest intensity that should be recognized as a peak can be entered. You can type in any value for MI or go to the “Set to” button and choose either the lowest contour level, the MI value already stored with the dataset or the MI value used during the last peak picking routine. If the value is too low, too many peaks will be picked, if it is set to a too high value, weak peaks will be missed. A similar limitation can be applied to the maximum intensity. If MAXI is set to a smaller value than 1, every peak that has a higher intensity will not be picked. The diagonal gap allows to define a certain number of points around the diagonal, that will not be considered during peak picking. That way the diagonal peaks of homonuclear spectra will not be entered in the

peak list. The smaller the resolution value is, the closer 2 peaks may be to be still considered as 2 separate peaks.

For a ROESY only positive peaks need to be detected.

Manual peak picking: The manual peak picking mode can be started either from the peak picking dialog box by pressing the button  or directly from the main TopSpin window by clicking on the icon . You will enter the peak picking window. Set the cursor over a peak, click with the right mouse button and confirm, that the peak should be added to the peak list. To delete a peak, right click on an already marked peak and click on “Delete Peak From List”. If you click on “Annotate Peak” it is possible to add any desired assignment to the peak. Leave the dialog with the  button.

8.4.2 Projections

It is possible to show 1D spectra on either side of the 2D plot. This may be helpful, to identify cross peaks within spectrum. To toggle the display of the projections on, right click on the 2D spectrum and select the “Display Properties...”. In the dialog window toggle on the option “Show projections”. On the bottom it is possible to choose, whether the projections in F1, in F2 or in both dimensions should be visible. The moment, the projection display is turned on the positive projections are displayed above the spectrum and to the left as a default.

Display of a recorded 1D proton spectrum: Right click with the mouse over the displayed projection and choose the option “External projection”. A dialog box will open where you can type in the path information of the dataset that should be displayed.

Alternatively it is possible to start a projection display dialog box with the command **projd**. On top the option “Display 1D spectra along with the 2D spectrum” should be toggled on. If the checkbox is ticked it is possible to enter any 1D dataset for the F2 (left) and the F1 (right) dimension, respectively. After clicking **OK** the spectra will be displayed.

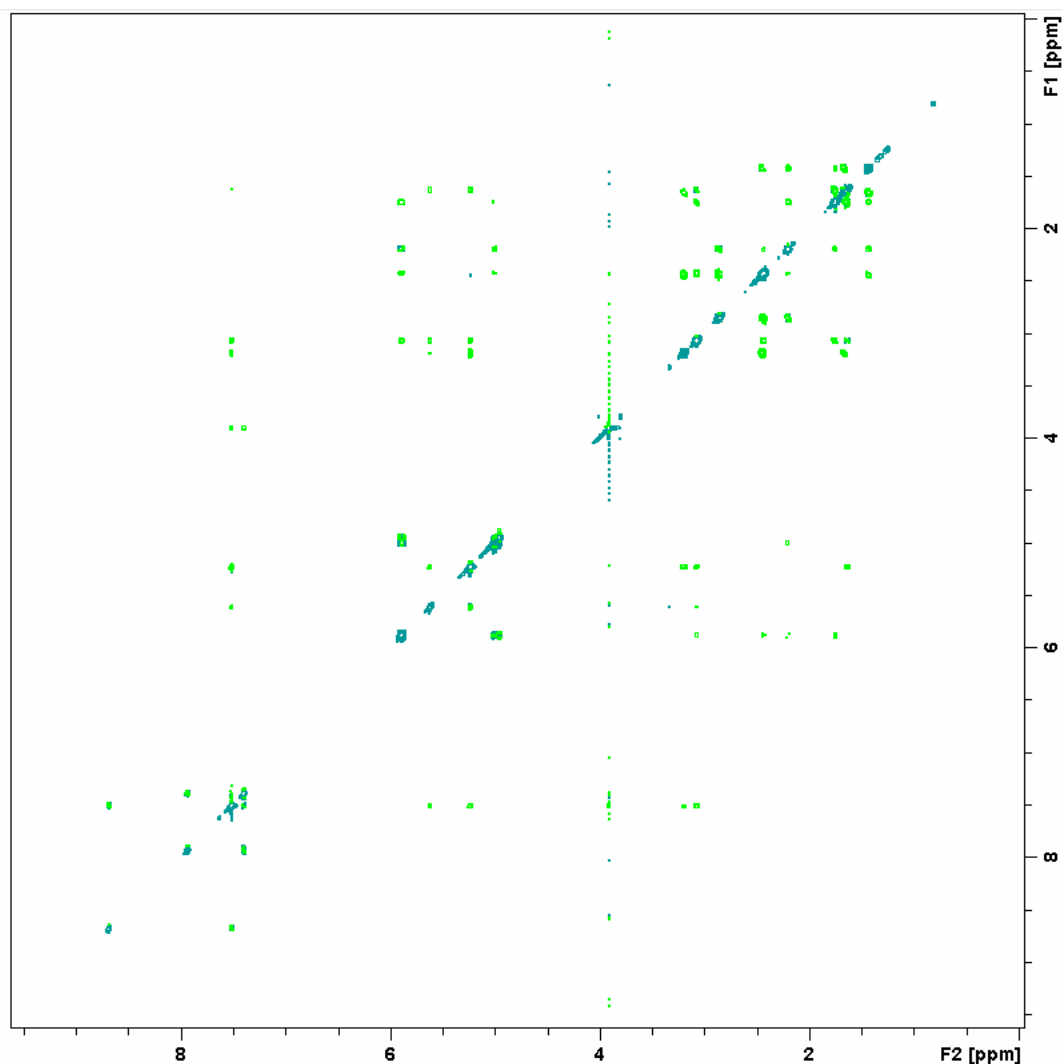
Display of internal projections: To switch back to the internal projections, right click over the projections and choose the option “Internal Projection”. The positive internal projection will be displayed again.

Alternatively it is again possible to use the command **projd** and toggle on the option “Display projections along with the 2D spectrum” on the top. After clicking **OK** the internal positive projections will be displayed.

8.5 Spectra interpretation

A ROESY of 50 mM Quinine is shown in Figure 8.3. Compared to the NOESY (see Figure 7.3) the information content is the same.

Figure 8.3: ROESY of 50 nM Quinine.



Constitution and molecular structure: In contrast to a COSY spectrum that will show cross peaks if the protons are coupled through bonds, a ROESY will show cross peaks in between protons that are spatially close to each other.

Unlike the NOESY the cross peaks of a ROESY will always be positive, if the diagonal was phased negative.

The intensity of the cross peaks depends on the distance of the protons! Hence an accurate integration of the signals can yield quantitative information about through space distances within a given molecule. The intensity of the individual cross signals goes down with d^6 , where d is the distance of the protons. Therefore not only structural bonding information is available, but also the 3 dimensional structure can be retrieved from a ROESY.

8.6 Possible pitfalls

Using the standard parameter set, which is called up by typing **rpar ROESYPHSW all** and **getprosol** (see the chapter on data acquisition), will mostly lead to satisfactory spectra without the need to change parameters.

Some basic issues (lineshape, sample concentration and shim) should be checked already in the preparatory 1D proton experiment (see chapter 2)

However some common pitfalls and artifacts that may lead to unsatisfactory results are described here. We describe the most commonly observed phenomena and the causes as well as solutions to these relatively common things.

- For 2D experiments, spinning should always be turned off, as the spinning may introduce artefacts leading to criss cross noise in the spectra (see Figure 7.4). Note that you have to adjust the z and eventually also the z^2 shim, if you stop sample rotation. Therefore it is best to run already the preparatory 1D experiment without spinning.
- Especially in ROESY experiments, heating of the sample due to the rather long lasting spin lock pulse can not be completely prevented. Hence the temperature of the sample will rise a little bit upon the start of the experiment. After a short time, a temperature equilibrium will be reached again. It is important, not to start acquiring data before the equilibrium is established, otherwise the peaks will become distorted due to the different temperature at which the first increments were run (see Figure 6.2). To ensure this, choose enough dummy scans. At least 32 should be taken but it may be better to take even more. If you are not sure, whether sample heating is responsible for the bad lineshape, fourier transform the spectrum only in the direct dimension with the command **xf2** and check whether the signals are shifting during the first increments (see Figure 6.3).
- The number of scans and dummy scans needs to be a multiple of the minimum given in the pulse program. If that is not the case, the phase cycle is not completed which may lead to auxiliary diagonals parallel to the real diagonal (see Figure 6.4).
- Miscalibration of chemical shifts by up to 0.5ppm: This happens sometimes in the automation – either in IconNMR or using the **xaup** command – if no internal standard has been added. The reason is that the **sref** command finds a very small peak (possibly noise) close to 0ppm. It assumes that this is TMS and sets it to 0ppm. You may undo this by setting **sr** to 0Hz.

9 The HMQC Experiment

9.1 General information about the experiment

The HMQC (**H**eteronuclear **M**ultiple **Q**uantum **C**orrelation) correlates the proton signals to a directly bonded heteroatom, mostly ^{13}C . Of course basically every heteroatom can be chosen instead, but as carbon correlated spectra are the ones that are mostly run, we will discuss this as example here.

The HMQC is one example of the so called inverse spectroscopy, where the excited and the observed nucleus are the same (protons) and the heteronucleus is detected indirectly during an incremented delay. Some older methods (like HETCORR) used the direct observation of the heteronucleus after excitation of the protons and magnetization transfer. The advantage of the inverse spectroscopy is that the nucleus with the highest γ (^1H) is detected, and so it is possible to obtain the highest sensitivity. The challenge of an inverse chemical shift correlation experiment, however, is that the large signals from ^1H not coupled directly to a ^{13}C nucleus must be suppressed in a difference experiment. This poses a dynamic range problem: the signal of interest is that of ^1H coupled directly to ^{13}C nuclei; however, the signal detected is dominated by the contribution of ^1H bonded directly to ^{12}C nuclei. HMQC minimizes this dynamic range problem while optimizing the sensitivity of the experiment. The resonance frequency of low γ spins can be detected with enhanced sensitivity by the creation and ^1H detection of ^1H - ^{13}C (or other X nucleus) multiple-quantum coherence.

9.1.1 Pulse sequence and a few NMR details

The HMQC pulse sequence is shown in Figure 9.1, which should be used on samples consisting of proteins and other macromolecules. The first ^1H pulse creates transverse magnetization, some of which evolves into anti-phase magnetization at the end of the first $1/(2J_{\text{XH}})$ delay. This anti-phase magnetization is converted into multiple-quantum coherence by the $(\pi/2)_{\text{X}}$ pulse and evolves chemical shift during t_1 . A delay $1/(2J_{\text{XH}})$ is inserted between the final 90° pulse after t_1 and the start of the acquisition so that ^{13}C decoupling can be used during acquisition. Without this delay, the ^1H magnetization components would be anti-phase at the start of the acquisition and so ^{13}C decoupling would result in mutual cancellation of the ^1H signals.

Note that since it is the longitudinal ^1H magnetization present before the first $(\pi/2)_{\text{H}}$ pulse that is converted into heteronuclear multiple-quantum coherence, it is the ^1H T_1 which determines the appropriate recycle delay. Thus, it is possible to use a recycle delay appropriate for ^1H for an HMQC.

For small molecules, it is useful to use a BIRD preparation period in conjunction with the HMQC experiment (**Fehler! Verweisquelle konnte nicht gefunden werden.**). The basic idea of this preparation period is to saturate all ^1H not directly attached to a ^{13}C nucleus.

HMQC is a phase-sensitive experiment, and after a 2D Fourier transform with respect to t_1 and t_2 , the 2D spectrum can be phased so that all peaks are purely absorptive.

Figure 9.1: HMQC Pulse Sequence

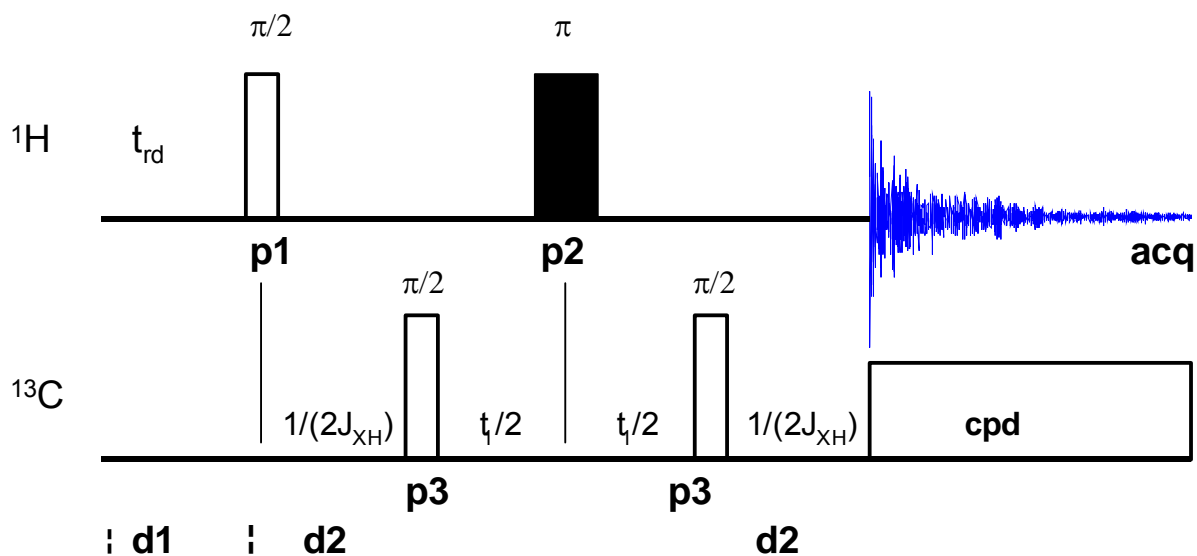
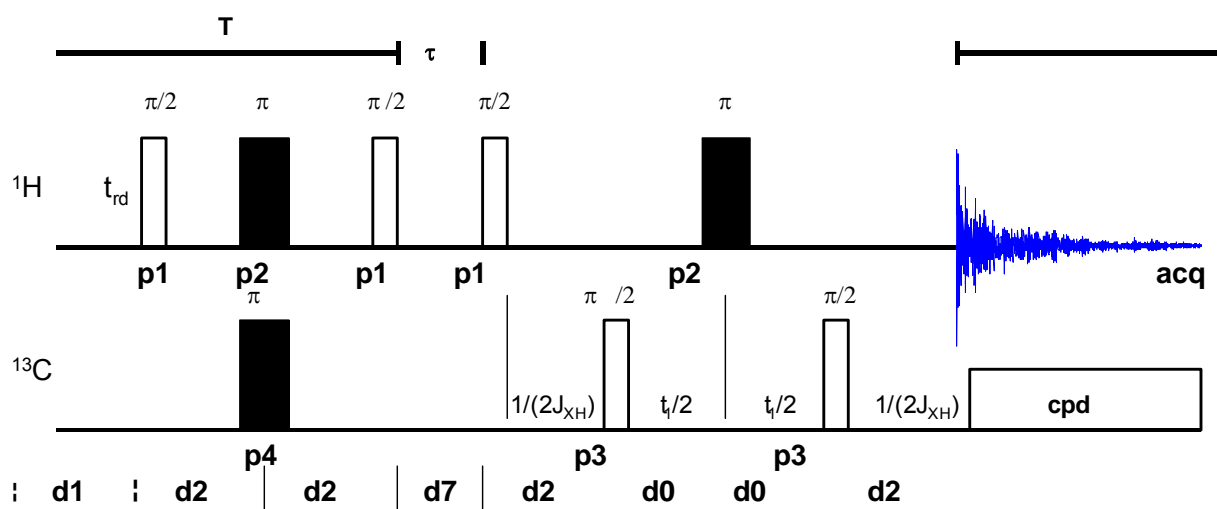


Figure 9.2: HMQC with BIRD Pulse Sequence



9.2 Preparation and Acquisition


The steps that belong to the spectral acquisition are all arranged in the NMR spectra acquisition guide, which may be invoked from the **Acquisition** → **Data Acquisition Guide** menu.

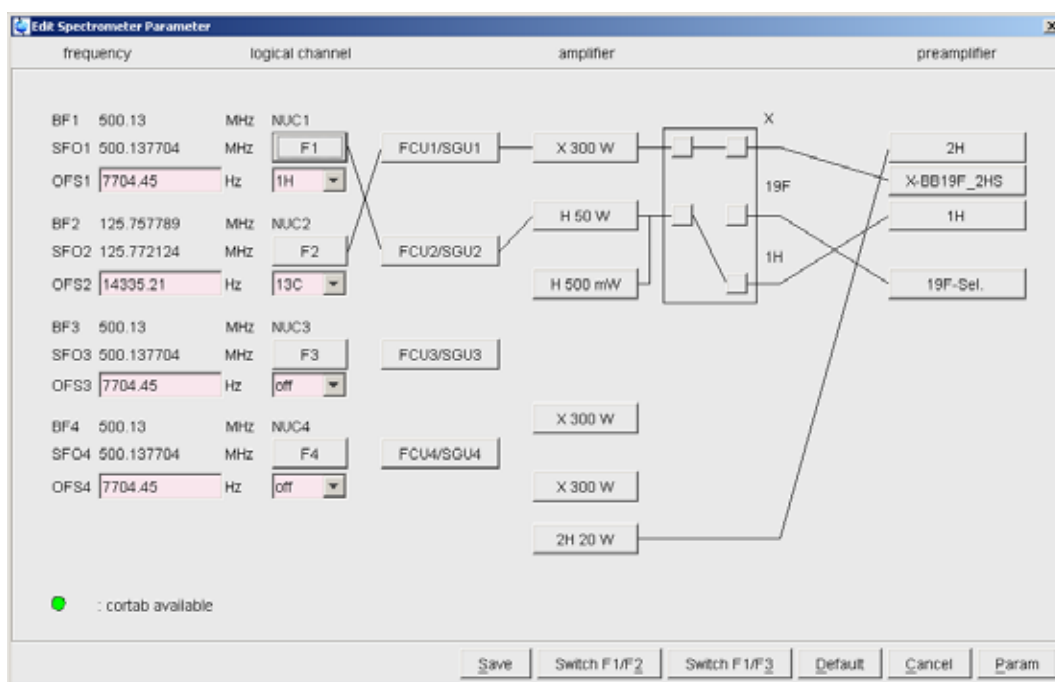
9.2.1 Data acquisition step by step

- Make sure that the sample tube is properly adjusted in the spinner if needed and insert it into the magnet. (For more information on sample preparation and handling, please refer to chapter 1.4).
- If needed, make a new dataset, type **edc** or **new** or select **File** → **New** from the menu.

Here, the dataset name, the experiment number (**EXPNO**), the processing number (**PROCNO**), the directory and the user name are entered. All of these entries will become directories on the respective hard-disk. (For more information on directory structures, refer to chapter 1.3).

You may also choose the correct solvent in the **Solvent** field and select a parameter-set here in the **Experiment** field. The experimental parameters for acquisition, processing, plotting and output will be loaded from the selected parameter-set as if you would have typed **rpar**. You may also give a title.

- Lock the sample by typing **lock** and select the correct solvent.
- Enter **edasp** or click on the button  and select "13C" for the second channel. Press "Save" to return to the main window.



- Match and tune the sample either manually by typing **wobb** and physically adjusting the matching and tuning sliders or screws on the probe for both channels – if you do not have an ATM probe – or automatically by typing **atma** – if you do have an ATM probe.
- Shim the sample either manually or by using the gradient shimming automation routine, type **gradshimau**.
- If you have not selected a parameter set yet (see above), type **rpar PROTON all**. This will select the 1D PROTON standard parameters. (For more information on parameter-sets, refer to chapter 1.3.)

- Type **getprosol** and run a preparatory 1D proton experiment to judge spectra quality and to get a reference for sweep width and transmitter offset (see chapter 2).
- Increase the experiment number in the same experiment set by typing **edc** and changing experiment number and eventually the parameter set to HMQCPH or HMQCBIPH, respectively. You can also type in the command **iexpno** instead. This will just increase the experiment number by 1.
- If you have not selected a parameter set yet (see above), type **rpar HMQCPH all** or **rpar HMQCBIPH all**, respectively. This will select the HMQC standard parameters, which may be used as they are or which may be adjusted to your needs later. (For more information on parameter-sets, refer to chapter 1.3.)
- Type **getprosol** to load the probe dependent parameters!
- Type in the command **edc2** to define the reference proton spectrum. Enter the correct experiment and processing number in the according field of data set 2. If a 1D carbon spectrum exists, it can be entered as data set 3.

	Data Set 2	Data Set 3
NAME =	Quinine	Quinine
EXPNO =	1	1
PROCNO =	1	1
DIR =	C:\u	C:\u
USER =	los	los

- Adjust acquisition parameters or start the acquisition. We recommend that you use the automation mode by typing **xaua**. You may also start the receiver gain adjustment manually (type **rga**) and then start the acquisition and type **zg**.

9.2.2 Important acquisition parameters for this experiment

There are some acquisition parameters that may be modified for this experiment. The values of the parameters may be edited by clicking the AcqPars tag in the main window. You may access the full set of all acquisition parameters also by typing **eda** or a reduced set, where only parameters are displayed that are relevant for the selected pulse program by typing **ased**. Each parameter may also be accessed by typing its name in lower case letters.

In contrast to the 1D experiments there are 2 columns visible in the acquisition parameter editor. The first column belongs to the direct or F2 dimension, the second one to the indirect or F1 dimension. Note that for inverse heteronuclear experiments, the proton parameters are set in the

direct dimension F2, whereas the parameters for the heteroatom are set in the indirect dimension F1.

Table 9.1: Acquisition parameters that may be adjusted from the default parameter-set

F2 Parameters		
Parameter	Explanation	Comments and possible values
PULPROG	pulse program for the acquisition	Use the hmqcph pulse program which yields a phase sensitive standard HMQC. For small molecules the pulse program hmqcbiph should be used.
NS	number of scans	The minimum number of scans is 4. You can use any multiple of 4 to yield a more intense signal, however the experiment lasts longer then.
DS	dummy scans	16 dummy scans are appropriate for this experiment.
TD, AQ	time-domain, acquisition time	These 2 values depend on each other. To avoid too much data td in F2 is generally set to 2k.
SW	spectral width	sw (in ppm, or correspondingly swh in Hz) defines the width of the proton spectral window and it has to be large enough to incorporate all peaks of the spectrum. Choose the whole range where signals are visible plus one additional ppm to either side. If you run a 1D proton spectrum in advance, define it as a reference with edc2 and start the acquisition with xaua , an automatic sweep range adjustment will be done.
O1P	transmitter offset	o1p (in ppm or o1 in Hz or sfo1 in MHz) defines the center of the proton spectral window (sw or swh). The signals should be centered around this value. If you run a 1D proton spectrum in advance, define it as reference with edc2 and start the acquisition with xaua , an automatic offset adjustment will be done.
D1	recycling delay between two	To save time, d1 is set to about 1.25*T1 of the protons. For most

	scans	molecules, 1.5-2 s is an appropriate value.
CNST2	¹ J(CH) coupling constant	The typical value is 145 Hz for an intermediate one bond CH coupling constant. This value will yield good signals for almost all common molecules. However, it may be a good idea to adjust the value, if the molecule contains for example only aromatic carbon atoms. The program will automatically calculate the delay d2 necessary for an effective magnetization transfer from cnst2 .
RG	receiver gain	This is automatically adjusted using the commands xaua or rga .
NUC1	nucleus in F1	For inverse experiments this is ¹ H.
P1, PL1	probe dependant pulse length and high power level	These parameters are dependant on the individual probe and are loaded by the getprosol command. p1 defines the length of the 90° proton pulse at the power level pl1 .
F1 Parameters		
Parameter	Explanation	Comments and possible values
TD	number of experiments	This value determines how many points are recorded in the indirect dimension. 256 is an appropriate value.
FnMODE	determines quadrature detection in F1	For phase sensitive spectra you can choose States, TPPI or States-TPPI as quadrature detection method.
ND_010	number of incremented delays	2. There are two incremented delays in the experiment.
SW	sweep width	Choose it large enough to cover the whole chemical shift range of the carbon atoms bound directly to a proton. As quaternary carbon atoms will not give rise to any signal in an HMQC 160 ppm is usually enough. This value will <u>not</u> be automatically adjusted. Note that signals that are outside the range defined by sw and o2p will

		fold in the spectrum!
O2P	¹³ C offset	o2p (in ppm or o2 in Hz or sfo2 in MHz) defines the centre of the carbon window (sw or swh). It should be chosen in a way, that the expected signals are centred around this value. 80 ppm is an appropriate value. This value will <u>not</u> be automatically adjusted. Note that signals that are outside the range defined by sw and o2p will fold in the spectrum!
NUC1	nucleus in F1	Set it to 13C.
P3, PL2	probe dependant pulse length and high power level	These parameters are dependant on the individual probe and are loaded by the getprosol command. p3 defines the length of the 90° carbon pulse at the power level pl2 .
CPDPRG2	decoupling pulse sequence	This determines the composite pulse sequence that will be used for carbon decoupling during the acquisition time. A garp sequence is used here.
PCPD2, PL12	Probe dependant decoupling pulse length and power	These parameters are dependant on the individual probe and magnetic field. They are loaded with the getprosol command. pcpd2 defines the length of a low power 90° pulse used by the decoupling sequence while pl12 is the corresponding power.

9.3 Spectral processing

After the spectral acquisition has finished, the data has to be processed. You may do this either automatically using the **xaup** command or manually.

9.3.1 Automatic processing

The command **xaup** will invoke the automation AU program that is stored along with the processing parameters in the **aunmp** parameter. In this case the **aunmp** AU program is called **proc_2dinv**.

Typing **xaup** will automatically process the data and thus it will generate a phase corrected spectrum and it will also perform a baseline correction. By default, a plot will be created using the plot-layout which is also stored in the

processing parameters. For the HMQCPH and the HMQCBIPH parameter-sets this layout file is called **2D_inv.xwp**.

9.3.2 Manual processing

The acquired data may also be processed manually. The steps that belong to the spectral processing are all arranged in the NMR data processing guide, which may be invoked from the **Processing → Data Processing Guide** menu.

Window function: In 2D experiments the window functions can be used to diminish truncation artefacts, to enhance wanted signals over unwanted (for example diagonal peaks) and to improve the peak shape.


As the number of acquired points in a 2D experiment must be kept rather low for time reasons and to avoid too much data, the recorded FID is heavily truncated. The same issue occurs in the indirect dimension, although here the effect is even bigger, as the number of increments defines the number of points here. To avoid truncation artefacts (wiggles) in the resulting spectrum, sine-functions are used in both dimensions to force the FID to go down to zero.


To set the window functions it is easiest to click on the tag ProcPars and go to the sub menu Window Functions. For the parameter WDW several functions can be chosen from the pull down menu. Use SINE for a normal sine bell function or QSIN for a squared sine bell function, which approaches the zero value at the end of the FID a little smoother, than the pure sine bell.


SSB is a value that determines, by how much the sine function is shifted. If it is set to 0, the maximum is in the beginning of the curve. If it is set to a value n , the sine bell is shifted by π/n . For a phase sensitive HMQC **ssb** should be set to 2 in both dimensions. If there are still some wiggles occurring after the fourier transformation. Try some other values for **ssb** (3 or 4) and see whether this improves the appearance of the spectrum.


Fourier transformation: After the application of the window function, the time domain data has to be Fourier transformed to yield a frequency domain spectrum. This is achieved with the command **xfb**.

Phase correction: After fourier transformation, the spectrum needs to be phased. There is an au-program that takes care of an automatic phase correction. It can be started with the command **calcphin**. The program calculates the required values for a phase correction in F1 and F2. After this the data needs to be fourier transformed again to apply the calculated phase correction.


It is also possible to manually phase correct the spectrum. Click the phase correction button  or type **ph** and select **manual phasing** from the dialogue window. The window will now show the spectrum with a cursor cross and some icons on top. Now some rather strong peaks should be selected that are spread as far as possible over the spectral range. To do this move the mouse, until the cursor is over a peak, click the right mouse button and select **Add** from the menu. That way, the rows and columns along the cursor cross will be added to the rows and columns that will be shown when going to the phasing itself.


To adjust the phasing of the rows, click on the  button. The selected rows will be displayed as 1D spectra. The position of the reference- or pivot point is indicated by a red vertical line. By default, the highest peak of the first row is defined as the pivot point. However, this may be a peak which is located in the central part of the spectrum. If this is the case it is advisable to define a peak somewhere close to the edge of one of the rows as pivot point. Move the cursor over the peak, press the right mouse button and select **Set Pivot Point** from the context menu.

Use zero order phase correction to correct the phase around the area of the pivot point: place the cursor over the , hold down the left mouse button and move the mouse up or down. Thus, adjust the 0 order phase value until the baseline around the peak at the pivot point is flat and the peak itself is positive.

Then adjust the first order phase value in the same way by holding down the left mouse button over the  button. Move the mouse up and down until a cross peak on the opposite side of the spectral region is phased and the baseline around this peak is flat as well.

Note that it may not be possible to phase all peaks into pure absorption, as they may be dephased as well in the indirect dimension. If this is the case, some peaks will contain a negative part. Therefore it may be more useful to look at the baseline, than just at the peaks phase.

By clicking the save-and-return button () , the phase correction will be applied to the spectrum and the values for zero- and first order phase correction will be stored to the corresponding processing parameters of the F2 dimension: **phc0** and **phc1**. Whenever you type **xfb** these phase correction values will be taken into account, as long as the PH_mod under the ProcPars is set to pk.


Now the spectrum may still be out of phase in the indirect dimension. Press the button  and proceed with the phasing of the columns exactly the same way, as with the rows. The resulting phase correction will then be automatically entered into the parameters **phc0** and **phc1** of the indirect dimension F1.

Leave the phasing by clicking the button .

Calibration and referencing: The chemical shift ppm axis may be calibrated. The **sref** command automatically looks for a peak at around 0ppm (± 0.5 ppm) and assumes that this is the TMS or another internal reference substance. It will then calibrate the axes of the spectrum in a way that this peak is at exactly 0ppm in both dimensions. If **sref** does not find a peak at around 0 ppm, it uses the solvent information for the axis calibration.

This method only works unambiguously if you have added TMS or another internal reference compound to your sample and if no peaks from your compound are in the area around 0ppm.

You may also use the manual mode to calibrate the spectrum. Zoom into a diagonal peak of interest, which you'd like to set to a certain ppm value (e.g. a strong signal whose chemical shift is known). To zoom into a certain region of a spectrum, hold down the left mouse button in the spectrum display and

drag the cursor over the area of interest. Then click on this button  to enter the manual calibration mode.

Place the cross of the cursor over the center of the peak that you'd like to use for calibration and click the left mouse button. Enter the desired frequency for both dimensions into the calibration window that opens up. Click **OK** and you're taken back to the default display and the axis calibration is stored into the processing parameters as the **sr** parameter. This parameter is also adjusted by the **sref** command.

Baseline correction: The baseline of the spectrum may be corrected automatically. This has to be done separately for both dimensions. Type **abs2** and then **abs1**. This will perform the correction first in the F2 dimension and then in F1. The commands will apply a polynomial baseline correction where the order of the polynomial function is defined by the processing parameter **absg**. The value of **absg** may range between 0 and 5. The default values of **absg** stored with the HMQCPH and the HMQCBIPH parameter sets are 5 for both dimensions.

Automatic baseline correction may also be applied only for parts of the spectrum. The processing parameters **absf1** and **absf2**, which can be found under the ProcPars tag for both dimensions, define the left and the right limit of the spectral region (in ppm), where the baseline correction should be applied. Then use the command **absf1** and **absf2**, respectively to correct only the selected regions.

9.3.3 Processing parameters

The processing parameters may be displayed by selecting the ProcPars tag in the TopSpin display window or by typing **edp**. Some of these processing parameters govern certain processing commands and may be optimized before the application of the respective processing command. Each parameter may also be accessed by typing its name in lower case letters.

Table 9.2: Processing parameters that may be adjusted from the default parameter-set

F2 Parameters		
Parameter	Explanation	Comments and possible values
SI	Size of the real spectrum	This corresponds to TD in the acquisition parameters. si defines the number of real data points that are used for the processing. If the value for si is larger than $\frac{1}{2}$ td , zero filling is applied since td is given in complex numbers. Zero filling smoothes spectra, so usually si = td . If si < $\frac{1}{2}$ td , then some of the acquired data points are not taken into account!
SR	Spectral reference	This parameter is altered by the spectral referencing. It is 0 if no axis referencing is performed.

WDW	Type of the window function	This parameter defines, which type of a window function will be applied in the direct dimension. Choose SINE or QSINE
SSB	Shifted sine bell	ssb determines where the maximum of the applied sine bell window function is. Set it to 2 for phase sensitive spectra.
PH_mod	Phase correction mode	This must be set to pk. The phase values of ph0 and ph1 will then automatically be applied in all proceeding fourier transformations.
ABSG	order of the polynomial for abs	$0 \leq \mathbf{absg} \leq 5$. Usually absg = 5 works for most spectra.
BC_mod	Baseline correction on the FID	This value determines the polynomial order of the baseline correction that is performed on the FID. Set it to quad.

F2 Parameters

Parameter	Explanation	Comments and possible values
SI	Size of the real spectrum	If the value for si is larger than $\frac{1}{2} \mathbf{td}$, zero filling is applied on phase sensitive spectra since td is given in complex numbers. Zero filling smoothes spectra, so usually si = td . If si < $\frac{1}{2} \mathbf{td}$, then some of the acquired data points are not taken into account!
SF	Spectral reference	This parameter is altered by the spectral referencing. It is 0 if no axis referencing is performed.
WDW	Type of the window function	This parameter defines, which type of a window function will be applied in the direct dimension. Choose SINE or QSINE
SSB	Shifted sine bell	ssb determines where the maximum of the applied sine bell window function is. Set it to 2 for phase sensitive spectra.
PH_mod	Phase correction mode	This must be set to pk. The phase values of ph0 and ph1 will then automatically be applied in all proceeding fourier transformations.

MC2	Type of fourier transformation	The value of mc2 depends on the FnMODE that was chosen during acquisition. Set it to States, TPPI or States-TPPI, respectively.
------------	--------------------------------	--

9.4 Post-processing

After the spectra are processed (Fourier transformed, referenced and baseline corrected), peaks may be picked and the spectrum may be plotted for further interpretation.

9.4.1 Peak picking

There are different options on how to perform peak picking.

In order to display the picked peaks, right click in the spectrum display window and select “display properties” from the context menu and tick the box “Peak labels”.

The picked peaks are stored in a peak list text file which may be displayed by selecting the “Peaks” tag in the main window. The peak list is interactive and you may correlate it with the spectrum and display spectrum and peak list at the same time. Right click in the peak list table and select “show spectrum” → “in correlated window” from the context menu. If you now move the mouse cursor over any entry in the list, the cursor in the spectrum will automatically jump to the corresponding peak in the spectrum. The peak list may also be exported as a text file or peak list file. Right click in the peak list window and select the “export” option from the context menu.

Automatic peak picking on the displayed region: To start the peak picking dialog window, type in the command **pp**.

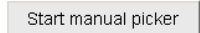


You have the option to append the data to a presumably already existing list. If this is not checked, the procedure will create a completely new peak list. If it is checked it may be wise to skip already existing peaks within that list, this means: not entering it a second time to the existing peaks.

The parameters that can be set include the region. Click on the “Set to” button. Here you can choose, whether you want to peak pick the complete processed spectral range, only the displayed region, the region that is defined by the F1/F2 parameters (which can be adjusted with the command **f1p** and **f2p**, respectively) or the region that was chosen during the last peak picking routine. Of course you can also type in the desired values directly in the peak picking dialog window. Note that the whole region can also be peak picked without opening the graphical interface with the command **ppf**, whereas only the region defined by **f1p** and **f2p** is used when the command **pps** was applied.

The sensitivity can be altered in several ways. First a lower limit for the smallest intensity that should be recognized as a peak can be entered. You can type in any value for MI or go to the “Set to” button and choose either the lowest contour level, the MI value already stored with the dataset or the MI value used during the last peak picking routine. If the value is too low, too

many peaks will be picked, if it is set to a too high value, weak peaks will be missed. A similar limitation can be applied to the maximum intensity. If MAXI is set to a smaller value than 1, every peak that has a higher intensity will not be picked. The smaller the resolution value is, the closer 2 peaks may be to be still considered as 2 separate peaks.

For an HMQC only positive peaks need to be detected.

Manual peak picking: The manual peak picking mode can be started either from the peak picking dialog box by pressing the button  or directly from the main TopSpin window by clicking on the icon . You will enter the peak picking window. Set the cursor over a peak, click with the right mouse button and confirm, that the peak should be added to the peak list. To delete a peak, right click on an already marked peak and click on “Delete Peak From List”. If you click on “Annotate Peak” it is possible to add any desired assignment to the peak. Leave the dialog with the  button.

9.4.2 Projections

It is possible to show 1D spectra on either side of the 2D plot. This may be helpful, to identify cross peaks within spectrum. To toggle the display of the projections on, right click on the 2D spectrum and select the “Display Properties...”. In the dialog window toggle on the option “Show projections”. On the bottom it is possible to choose, whether the projections in F1, in F2 or in both dimensions should be visible. The moment, the projection display is turned on the positive projections are displayed above the spectrum and to the left as a default.

Display of a recorded 1D proton or carbon spectrum: Right click with the mouse over the displayed projection and choose the option “External projection”. A dialog box will open where you can type in the path information of the dataset that should be displayed.

Alternatively it is possible to start a projection display dialog box with the command **projd**. On top the option “Display 1D spectra along with the 2D spectrum” should be toggled on. If the checkbox is ticked it is possible to enter any 1D dataset for the F2 (left) and the F1 (right) dimension, respectively. After clicking **OK** the spectra will be displayed.

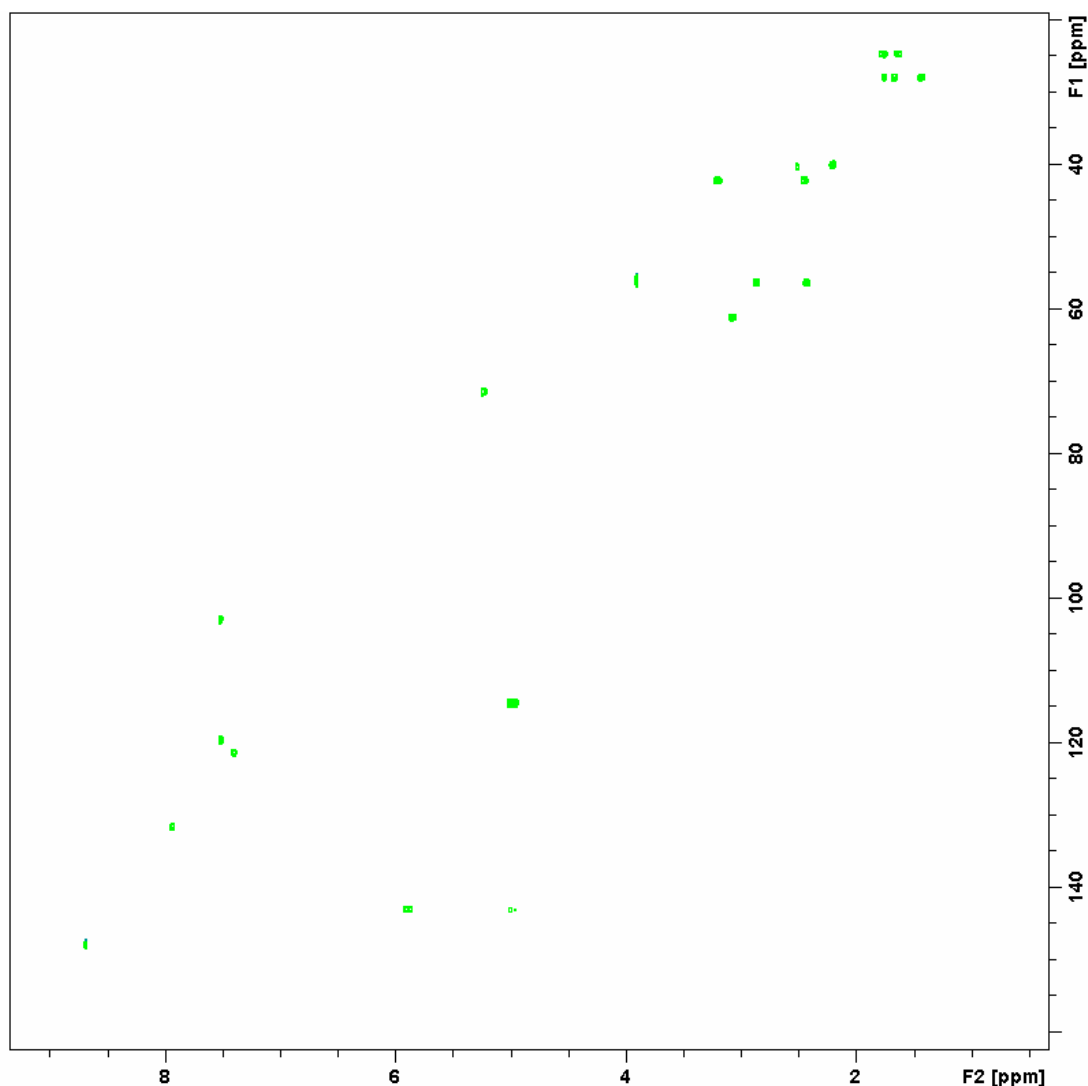
Display of internal projections: To switch back to the internal projections, right click over the projections and choose the option “Internal Projection”. The positive internal projection will be displayed again.

Alternatively it is again possible to use the command **projd** and toggle on the option “Display projections along with the 2D spectrum” on the top. After clicking **OK** the internal positive projections will be displayed.

9.5 Spectra interpretation

The HSQC of 50 mM Quinine in DMSO is shown in

Figure 9.3: HSQC of 50 mM Quinine in DMSO.



Constitution and molecular structure: In an HMQC cross peaks are showing a one bond coupling in between a proton and a carbon spectrum. Hence it is possible to find out, which protons are directly bonded to which carbon. It is also a rather quick method to record a carbon spectrum, as the sensitivity is higher than in a 1D carbon experiment and the relaxation delay can be chosen a little shorter. Note however, that quaternary carbon atoms will give no signal in an HMQC!

9.6 Possible pitfalls

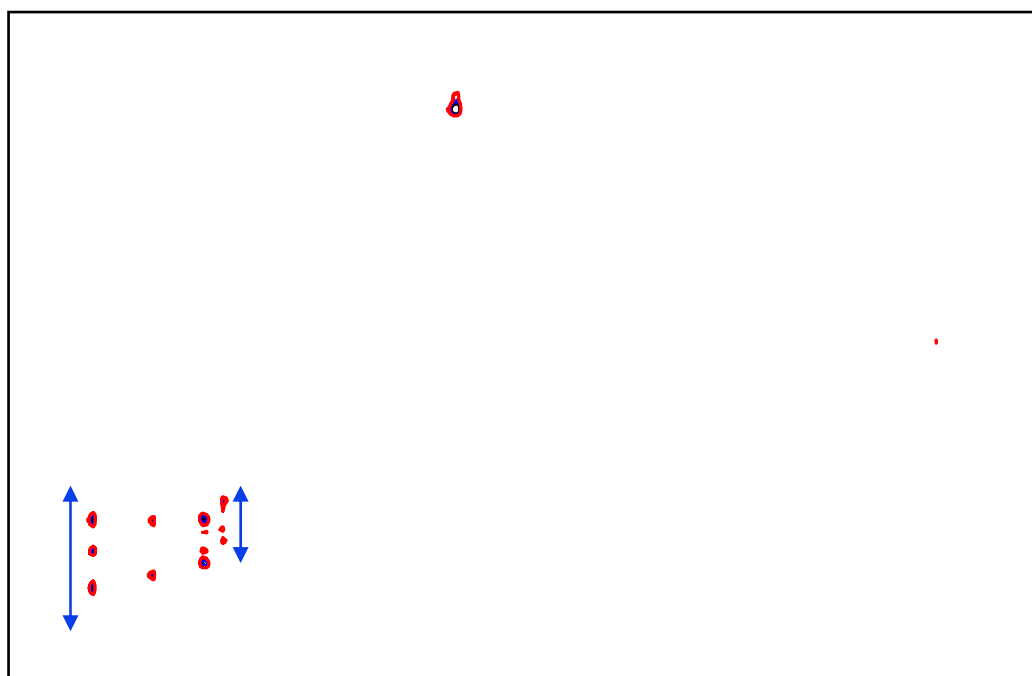
Using the standard parameter set, which is called up by typing **rpar HMQCPH all** or **rpar HMQCBIPH all**, respectively, and **getprosol** (see the chapter on data acquisition), will lead to satisfactory spectra without the need to change parameters.

Some basic issues (lineshape, sample concentration and shim) should be checked already in the preparatory 1D proton experiment (see chapter 2)

However some common pitfalls and artifacts that may lead to unsatisfactory results are described here. We describe the most commonly observed phenomena and the causes as well as solutions to these relatively common things.

- For 2D experiments, spinning should always be turned off, as the spinning may introduce artefacts leading to criss cross noise in the spectra (see Figure 7.4). Note that you have to adjust the z and eventually also the z^2 shim, if you stop sample rotation. Therefore it is best to run already the preparatory 1D experiment without spinning.
- The number of scans and dummy scans needs to be a multiple of the minimum given in the pulse program. If that is not the case, the phase cycle is not completed which may lead to auxiliary diagonals parallel to the real diagonal (see Figure 6.4).
- Pulse errors in the proton pulse lead to incomplete refocusing of the proton chemical shift during the evolution period t_1 , and hence to a splitting of the peaks along the F1-dimension (Figure 9.4). These artefacts can be easily assigned, as their distance from the correct correlation signal increases with the distance to the centre of the spectrum **o1p**.

Figure 9.4: Additional signals along F1 due to an improper setting of the proton pulse.



- Miscalibration of chemical shifts by up to 0.5ppm: This happens sometimes in the automation – either in IconNMR or using the **xaup** command – if no internal standard has been added. The reason is that the **sref** command finds a very small peak (possibly noise) close to 0ppm. It assumes that this is TMS and sets it to 0ppm. You may undo this by setting **sr** to 0Hz.

10 The HMBC Experiment

10.1 General information about the experiment

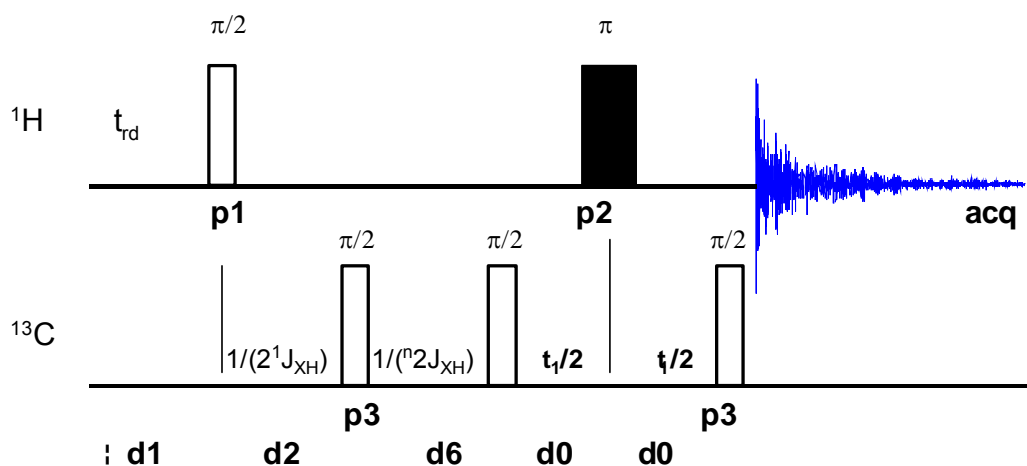
HMBC (**H**eteronuclear **M**ultiple **B**ond **C**orrelation) spectroscopy is a modified version of HMQC suitable for determining long-range ^1H - ^{13}C connectivities. Since it is a long-range chemical shift correlation experiment, HMBC provides the information about the carbon chemical shift of carbon atoms that are about 2-3 bonds away from the proton to which they correlate. Hence also quaternary carbon atoms will be detected.

10.1.1 Pulse sequence and a few NMR details

The HMBC pulse sequence is shown in Figure 10.1. The first ^{13}C 90° pulse, which is applied $1/(2^1J_{\text{XH}})$ after the first ^1H 90° pulse, serves as a low-pass J-filter to suppress one-bond correlations in the 2D spectrum by creating ^1H - ^{13}C heteronuclear multiple quantum coherence. This unwanted coherence is removed by phase cycling the first ^{13}C 90° pulse with respect to the receiver. After the delay Δ_2 of about 60msec, the second ^{13}C 90° pulse creates the desired heteronuclear multiple-quantum coherence for long-range ^1H - ^{13}C J-couplings. Phase cycling of the second ^{13}C 90° pulse removes signals from ^1H without long-range coupling to ^{13}C . The final ^{13}C 90° pulse after the t_1 evolution period is followed immediately by the detection period t_2 . The signal detected during t_2 is phase modulated by the homonuclear ^1H J-couplings. The 2D spectrum is generated by a Fourier transform with respect to t_1 and t_2 . If more than one long-range ^1H - ^{13}C connectivity is detected for one particular proton, the relative intensities of the corresponding resonances are directly related to the magnitude of the coupling constant.

Because of phase modulation the spectrum has peaks with a combined absorptive and dispersive lineshape. It is not possible to phase correct the spectrum so that the peaks are purely absorptive, and hence the spectrum must be presented in magnitude mode.

Figure 10.1: HMBC pulse sequence



10.2 Preparation and Acquisition


The steps that belong to the spectral acquisition are all arranged in the NMR spectra acquisition guide, which may be invoked from the **Acquisition** → **Data Acquisition Guide** menu.

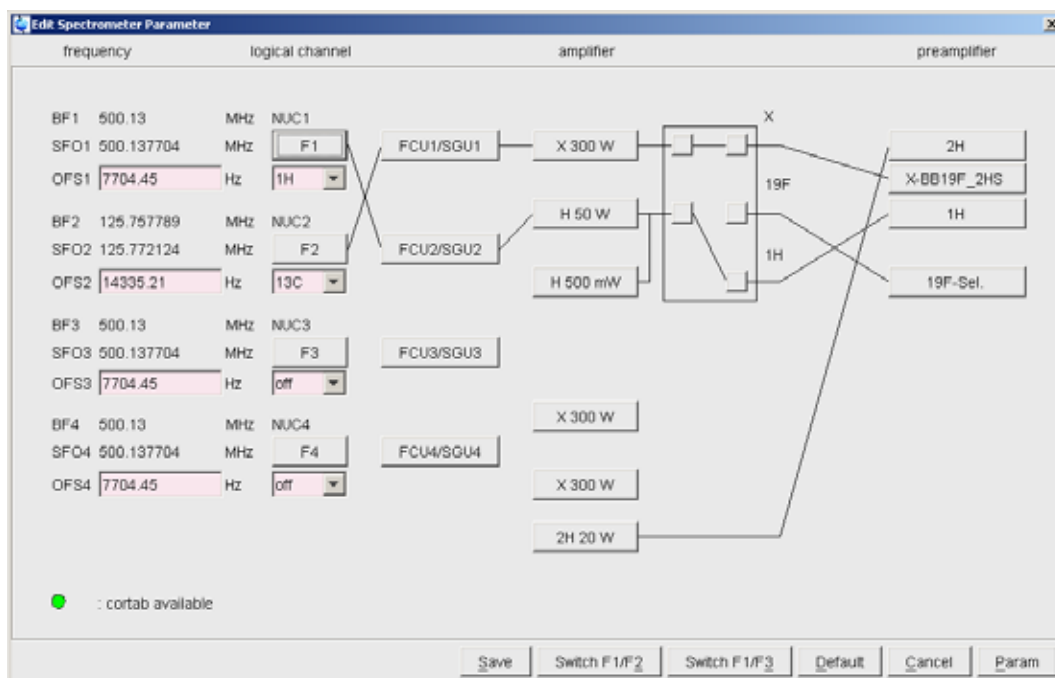
10.2.1 Data acquisition step by step

- Make sure that the sample tube is properly adjusted in the spinner if needed and insert it into the magnet. (For more information on sample preparation and handling, please refer to chapter 1.4).
- If needed, make a new dataset, type **edc** or **new** or select **File** → **New** from the menu.

Here, the dataset name, the experiment number (**EXPNO**), the processing number (**PROCNO**), the directory and the user name are entered. All of these entries will become directories on the respective hard-disk. (For more information on directory structures, refer to chapter 1.3).

You may also choose the correct solvent in the **Solvent** field and select a parameter-set here in the **Experiment** field. The experimental parameters for acquisition, processing, plotting and output will be loaded from the selected parameter-set as if you would have typed **rpar**. You may also give a title.

- Lock the sample by typing **lock** and select the correct solvent.
- Enter **edasp** or click on the button  and select "13C" for the second channel. Press "Save" to return to the main window.



- Match and tune the sample either manually by typing **wobb** and physically adjusting the matching and tuning sliders or screws on the probe for both channels – if you do not have an ATM probe – or automatically by typing **atma** – if you do have an ATM probe.

- Shim the sample either manually or by using the gradient shimming automation routine, type **gradshimau**.
- If you have not selected a parameter set yet (see above), type **rpar PROTON all**. This will select the 1D PROTON standard parameters. (For more information on parameter-sets, refer to chapter 1.3.)
- Type **getprosol** and run a preparatory 1D proton experiment to judge spectra quality and to get a reference for sweep width and transmitter offset (see chapter 2).
- Increase the experiment number in the same experiment set by typing **edc** and changing experiment number and eventually the parameter set to HMBCLPND. You can also type in the command **iexpno** instead. This will just increase the experiment number by 1.
- If you have not selected a parameter set yet (see above), type **rpar HMBCLPND all**. This will select the HMBC standard parameters, which may be used as they are or which may be adjusted to your needs later. (For more information on parameter-sets, refer to chapter 1.3.)
- Type **getprosol** to load the probe dependent parameters!
- Type in the command **edc2** to define the reference proton spectrum. Enter the correct experiment and processing number in the according field of data set 2. If a 1D carbon spectrum exists, it can be entered as data set 3.

Please specify data sets 2 and 3:		
NAME =	Quinine	Quinine
EXPNO =	1	1
PROCNO =	1	1
DIR =	C:\u	C:\u
USER =	los	los

OK Cancel

- Adjust acquisition parameters or start the acquisition. We recommend that you use the automation mode by typing **xaua**. You may also start the receiver gain adjustment manually (type **rga**) and then start the acquisition and type **zg**.

10.2.2 Important acquisition parameters for this experiment

There are some acquisition parameters that may be modified for this experiment. The values of the parameters may be edited by clicking the AcqPars tag in the main window. You may access the full set of all acquisition parameters also by typing **eda** or a reduced set, where only parameters are displayed that are relevant for the selected pulse program by typing **ased**. Each parameter may also be accessed by typing its name in lower case letters.

In contrast to the 1D experiments there are 2 columns visible in the acquisition parameter editor. The first column belongs to the direct or F2 dimension, the second one to the indirect or F1 dimension. Note that for inverse heteronuclear experiments, the proton parameters are set in the direct dimension F2, whereas the parameters for the heteroatom are set in the indirect dimension F1.

Table 10.1: Acquisition parameters that may be adjusted from the default parameter-set

F2 Parameters		
Parameter	Explanation	Comments and possible values
PULPROG	pulse program for the acquisition	Use the hmbclpndqf pulse program which yields a standard non decoupled magnitude mode HMBC.
NS	number of scans	The minimum number of scans is 16. You can use any multiple of 16 to yield a more intense signal, however the experiment lasts longer then.
DS	dummy scans	16 dummy scans are appropriate for this experiment.
TD, AQ	time-domain, acquisition time	These 2 values depend on each other. In the HMBC the signal of interest comes as an echo. If not enough time domain points td are recorded, the echo will be clipped. To avoid this set td to 4k.
SW	spectral width	sw (in ppm, or correspondingly swh in Hz) defines the width of the proton spectral window and it has to be large enough to incorporate all peaks of the spectrum. Choose the whole range where signals are visible plus one additional ppm to either side. If you run a 1D proton spectrum in advance, define it as a reference with edc2 and start the acquisition with xaua , an automatic sweep range adjustment will be done.
O1P	transmitter offset	o1p (in ppm or o1 in Hz or sfo1 in MHz) defines the center of the proton spectral window (sw or swh). The signals should be centered around this value. If you run a 1D proton spectrum in

		advance, define it as reference with edc2 and start the acquisition with xaua , an automatic offset adjustment will be done.
D1	recycling delay between two scans	To save time, d1 is set to about $1.25 \cdot T_1$ of the protons. For most molecules, 1.5-2 s is an appropriate value.
CNST2	$^1J(\text{CH})$ coupling constant	This constant is needed to calculate the delay d2 in between the 90° excitation pulse and the low pass filter pulse. Hence it should be adjusted to a typical one bond coupling constant. A typical value is 145 Hz.
CNST13	$^nJ(\text{CH})$ coupling constant	cnst13 corresponds to a typical long range coupling constant. It is used for the calculation of the delay d6 needed for an effective magnetization transfer from protons to a distant carbon atom. Typical values are in the range of 8-10 Hz.
RG	receiver gain	This is automatically adjusted using the commands xaua or rga .
NUC1	nucleus in F1	For inverse experiments this is ^1H .
P1, PL1	probe dependant pulse length and high power level	These parameters are dependant on the individual probe and are loaded by the getprosol command. p1 defines the length of the 90° proton pulse at the power level pl1 .

F1 Parameters

Parameter	Explanation	Comments and possible values
TD	number of experiments	This value determines how many points are recorded in the indirect dimension. As the signal builds up as an echo in the indirect dimension as well, 512 increments are appropriate for an HMBC.
FnMODE	determines quadrature detection in F1	No quadrature detection is needed in F1 for magnitude mode spectra. Set it to QF.
ND_010	number of incremented	2. There are two incremented delays in the experiment.

delays		
SW	sweep width	Choose it large enough to cover the whole chemical shift range of the carbon atoms. In contrast to the HMQC and the HSQC also quaternary carbon atoms may give rise to a signal in the HMBC. Therefore sw is usually set to 200 – 220 ppm. This value will <u>not</u> be automatically adjusted. Note that signals that are outside the range defined by sw and o2p will fold in the spectrum!
O2P	¹³ C offset	o2p (in ppm or o2 in Hz or sfo2 in MHz) defines the centre of the carbon window (sw or swh). It should be chosen in a way, that the expected signals are centred around this value. 100 - 110 ppm is an appropriate value. This value will <u>not</u> be automatically adjusted. Note that signals that are outside the range defined by sw and o2p will fold in the spectrum!
NUC1	nucleus in F1	Set it to 13C.
P3, PL2	probe dependant pulse length and high power level	These parameters are dependant on the individual probe and are loaded by the getprosol command. p3 defines the length of the 90° carbon pulse at the power level pl2 .

10.3 Spectral processing

After the spectral acquisition has finished, the data has to be processed. You may do this either automatically using the **xaup** command or manually.

10.3.1 Automatic processing

The command **xaup** will invoke the automation AU program that is stored along with the processing parameters in the **aunmp** parameter. In this case the **aunmp** AU program is called **proc_2dinv**.

Typing **xaup** will automatically process the data and thus it will generate a phase corrected spectrum and it will also perform a baseline correction. By default, a plot will be created using the plot-layout which is also stored in the processing parameters. For the HMBCLPND parameter-set this layout file is called **2D_inv.xwp**.

10.3.2 Manual processing

The acquired data may also be processed manually. The steps that belong to the spectral processing are all arranged in the NMR data processing guide, which may be invoked from the **Processing → Data Processing Guide** menu.

Window function: In 2D experiments the window functions can be used to diminish truncation artefacts, to enhance wanted signals over unwanted (for example diagonal peaks) and to improve the peak shape.

As the number of acquired points in a 2D experiment must be kept rather low for time reasons and to avoid too much data, the recorded FID is heavily truncated. The same issue occurs in the indirect dimension, although here the effect is even bigger, as the number of increments defines the number of points here. To avoid truncation artefacts (wiggles) in the resulting spectrum, sine-functions are used in both dimensions to force the FID to go down to zero.


To set the window functions it is easiest to click on the tag ProcPars and go to the sub menu Window Functions. For the parameter WDW several functions can be chosen from the pull down menu. Use SINE for a normal sine bell function or QSIN for a squared sine bell function, which approaches the zero value at the end of the FID a little smoother, than the pure sine bell.

SSB is a value that determines, by how much the sine function is shifted. If it is set to 0, the maximum is in the beginning of the curve. If it is set to a value n , the sine bell is shifted by π/n . For a magnitude mode HMBC **ssb** should be set to 0 in both dimensions. This will lead to a maximum intensity of the cross peaks and to a good lineshape.

Fourier transformation: After the application of the window function, the time domain data has to be Fourier transformed to yield a frequency domain spectrum. This is achieved with the command **xfb**.

Calibration and referencing: The chemical shift ppm axis may be calibrated. The **sref** command automatically looks for a peak at around 0ppm (± 0.5 ppm) and assumes that this is the TMS or another internal reference substance. It will then calibrate the axes of the spectrum in a way that this peak is at exactly 0ppm in both dimensions. If **sref** does not find a peak at around 0 ppm, it uses the solvent information for the axis calibration.

This method only works unambiguously if you have added TMS or another internal reference compound to your sample and if no peaks from your compound are in the area around 0ppm.

You may also use the manual mode to calibrate the spectrum. Zoom into a diagonal peak of interest, which you'd like to set to a certain ppm value (e.g. a strong signal whose chemical shift is known). To zoom into a certain region of a spectrum, hold down the left mouse button in the spectrum display and drag the cursor over the area of interest. Then click on this button  to enter the manual calibration mode.

Place the cross of the cursor over the center of the peak that you'd like to use for calibration and click the left mouse button. Enter the desired frequency for both dimensions into the calibration window that opens up. Click **OK** and you're taken back to the default display and the axis calibration is stored into

the processing parameters as the **sr** parameter. This parameter is also adjusted by the **sref** command.

Baseline correction: The baseline of the spectrum may be corrected automatically. This has to be done separately for both dimensions. Type **abs2** and then **abs1**. This will perform the correction first in the F2 dimension and then in F1. The commands will apply a polynomial baseline correction where the order of the polynomial function is defined by the processing parameter **absg**. The value of **absg** may range between 0 and 5. The default values of **absg** stored with the HMBCLPND parameter set are 5 for both dimensions.

Automatic baseline correction may also be applied only for parts of the spectrum. The processing parameters **absf1** and **absf2**, which can be found under the ProcPars tag for both dimensions, define the left and the right limit of the spectral region (in ppm), where the baseline correction should be applied. Then use the command **absf1** and **absf2**, respectively to correct only the selected regions.

10.3.3 Processing parameters

The processing parameters may be displayed by selecting the ProcPars tag in the TopSpin display window or by typing **edp**. Some of these processing parameters govern certain processing commands and may be optimized before the application of the respective processing command. Each parameter may also be accessed by typing its name in lower case letters.

Table 10.2: Processing parameters that may be adjusted from the default parameter-set

F2 Parameters		
Parameter	Explanation	Comments and possible values
SI	Size of the real spectrum	This corresponds to TD in the acquisition parameters. si defines the number of real data points that are used for the processing. If the value for si is larger than $\frac{1}{2}$ td , zero filling is applied since td is given in complex numbers. Zero filling smoothes spectra, so usually si = td . If si < $\frac{1}{2}$ td , then some of the acquired data points are not taken into account!
SR	Spectral reference	This parameter is altered by the spectral referencing. It is 0 if no axis referencing is performed.
WDW	Type of the window function	This parameter defines, which type of a window function will be applied in the direct dimension. Choose SINE or QSINE

SSB	Shifted sine bell	ssb determines where the maximum of the applied sine bell window function is. Set it to 0 for magnitude mode spectra.
PH_mod	Phase correction mode	No phase correction is applied on magnitude mode spectra. Set it to no .
ABSG	order of the polynomial for abs	$0 \leq \mathbf{absg} \leq 5$. Usually absg = 5 works for most spectra.
BC_mod	Baseline correction on the FID	This value determines the polynomial order of the baseline correction that is performed on the FID. Set it to quad.

F1 Parameters

Parameter	Explanation	Comments and possible values
SI	Size of the real spectrum	If the value for si is larger than td , zero filling is applied on magnitude mode spectra. Zero filling smoothes spectra, so usually si = 2* td . If si < td , then some of the acquired data points are not taken into account!
SF	Spectral reference	This parameter is altered by the spectral referencing. It is 0 if no axis referencing is performed.
WDW	Type of the window function	This parameter defines, which type of a window function will be applied in the direct dimension. Choose SINE or QSINE
SSB	Shifted sine bell	ssb determines where the maximum of the applied sine bell window function is. Set it to 0 for magnitude mode spectra.
PH_mod	Phase correction mode	A magnitude calculation is applied in the indirect dimension. Set it to mc .
MC2	Type of fourier transformation	The value of mc2 depends on the FnMODE that was chosen during acquisition. Set it to qf.

10.4 Post-processing

After the spectra are processed (Fourier transformed, referenced and baseline corrected), peaks may be picked and the spectrum may be plotted for further interpretation.

10.4.1 Peak picking

There are different options on how to perform peak picking.

In order to display the picked peaks, right click in the spectrum display window and select “display properties” from the context menu and tick the box “Peak labels”.

The picked peaks are stored in a peak list text file which may be displayed by selecting the “Peaks” tag in the main window. The peak list is interactive and you may correlate it with the spectrum and display spectrum and peak list at the same time. Right click in the peak list table and select “show spectrum” → “in correlated window” from the context menu. If you now move the mouse cursor over any entry in the list, the cursor in the spectrum will automatically jump to the corresponding peak in the spectrum. The peak list may also be exported as a text file or peak list file. Right click in the peak list window and select the “export” option from the context menu.

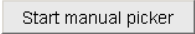


Automatic peak picking on the displayed region: To start the peak picking dialog window, type in the command **pp**.

You have the option to append the data to a presumably already existing list. If this is not checked, the procedure will create a completely new peak list. If it is checked it may be wise to skip already existing peaks within that list, this means: not entering it a second time to the existing peaks.

The parameters that can be set include the region. Click on the “Set to” button. Here you can choose, whether you want to peak pick the complete processed spectral range, only the displayed region, the region that is defined by the F1/F2 parameters (which can be adjusted with the command **f1p** and **f2p**, respectively) or the region that was chosen during the last peak picking routine. Of course you can also type in the desired values directly in the peak picking dialog window. Note that the whole region can also be peak picked without opening the graphical interface with the command **ppf**, whereas only the region defined by **f1p** and **f2p** is used when the command **pps** was applied.

The sensitivity can be altered in several ways. First a lower limit for the smallest intensity that should be recognized as a peak can be entered. You can type in any value for MI or go to the “Set to” button and choose either the lowest contour level, the MI value already stored with the dataset or the MI value used during the last peak picking routine. If the value is too low, too many peaks will be picked, if it is set to a too high value, weak peaks will be missed. A similar limitation can be applied to the maximum intensity. If MAXI is set to a smaller value than 1, every peak that has a higher intensity will not be picked. The smaller the resolution value is, the closer 2 peaks may be to be still considered as 2 separate peaks.

For a HMBC only positive peaks need to be detected.

Manual peak picking: The manual peak picking mode can be started either from the peak picking dialog box by pressing the button  or directly from the main TopSpin window by clicking on the icon . You will enter the peak picking window. Set the cursor over a peak, click with the right mouse button and confirm, that the peak should be added to the peak list. To delete a peak, right click on an already marked peak and click on "Delete Peak From List". If you click on "Annotate Peak" it is possible to add any desired assignment to the peak. Leave the dialog with the  button.

10.4.2 Projections

It is possible to show 1D spectra on either side of the 2D plot. This may be helpful, to identify cross peaks within the spectrum. To toggle the display of the projections on, right click on the 2D spectrum and select the "Display Properties...". In the dialog window toggle on the option "Show projections". On the bottom it is possible to choose, whether the projections in F1, in F2 or in both dimensions should be visible. The moment, the projection display is turned on the positive projections are displayed above the spectrum and to the left as a default.

Display of a recorded 1D proton or carbon spectrum: Right click with the mouse over the displayed projection and choose the option "External projection". A dialog box will open where you can type in the path information of the dataset that should be displayed.

Alternatively it is possible to start a projection display dialog box with the command **projd**. On top the option "Display 1D spectra along with the 2D spectrum" should be toggled on. If the checkbox is ticked it is possible to enter any 1D dataset for the F2 (left) and the F1 (right) dimension, respectively. After clicking **OK** the spectra will be displayed.

Display of internal projections: To switch back to the internal projections, right click over the projections and choose the option "Internal Projection". The positive internal projection will be displayed again.

Alternatively it is again possible to use the command **projd** and toggle on the option "Display projections along with the 2D spectrum" on the top. After clicking **OK** the internal positive projections will be displayed.

10.5 Spectra interpretation

.Constitution and molecular structure: In an HMBC cross peaks are showing a long range coupling in between a proton and a carbon spectrum. Hence it is possible to find out, which protons are directly bonded to which carbon. It is also a rather quick method to record a carbon spectrum, as the sensitivity is higher than in a 1D carbon experiment and the relaxation delay can be chosen a little shorter. Note however, that quaternary carbon atoms will give no signal in an HMQC!

10.6 Possible pitfalls

Using the standard parameter set, which is called up by typing **rpar HMBCLPND all**, respectively, and **getprosol** (see the chapter on data

acquisition), will lead to satisfactory spectra without the need to change parameters.

Some basic issues (lineshape, sample concentration and shim) should be checked already in the preparatory 1D proton experiment (see chapter 2)

However some common pitfalls and artifacts that may lead to unsatisfactory results are described here. We describe the most commonly observed phenomena and the causes as well as solutions to these relatively common things.

- For 2D experiments, spinning should always be turned off, as the spinning may introduce artefacts leading to criss cross noise in the spectra (see Figure 7.4). Note that you have to adjust the z and eventually also the z^2 shim, if you stop sample rotation. Therefore it is best to run already the preparatory 1D experiment without spinning.
- If the acquisition time is not long enough or the number of increments is too small, the echo signal will be clipped. This may lead to unreliable peaks in the spectrum, while the real long range peaks may be very weak or missing.
- The number of scans and dummy scans needs to be a multiple of the minimum given in the pulse program. If that is not the case, the phase cycle is not completed which may lead to auxiliary diagonals parallel to the real diagonal (see Figure 6.4).
- Miscalibration of chemical shifts by up to 0.5ppm: This happens sometimes in the automation – either in IconNMR or using the **xaup** command – if no internal standard has been added. The reason is that the **sref** command finds a very small peak (possibly noise) close to 0ppm. It assumes that this is TMS and sets it to 0ppm. You may undo this by setting **sr** to 0Hz.
- Pulse errors in the proton pulse lead to incomplete refocusing of the proton chemical shift during the evolution period t_1 , and hence to a splitting of the peaks along the F1-dimension (see Figure 9.4). These artefacts can be easily assigned, as their distance from the correct correlation signal increases with the distance to the centre of the spectrum **o1p**.

11 The HSQC Experiment

11.1 General information about the experiment

The HSQC (Heteronuclear Single Quantum Correlation) correlates the proton signals to a directly bonded heteroatom, mostly ^{13}C . Of course basically every heteroatom can be chosen instead, but as carbon correlated spectra are the ones that are mostly run, we will discuss this as example here.

Like the HMQC, the HSQC delivers information about the chemical shift of the directly bonded carbons. Compared to the HMQC experiment no line broadening along the ω_1 dimension appears as only ^{13}C single-quantum magnetization is present during the t_1 evolution period. On the other hand, the pulse sequence is much more complex and thus more sensitive towards pulse errors. While the HMQC will always yield some cross peaks, as long as the proton pulse is calibrated correctly, the HSQC will show severe artefacts if the pulse of the heteroatom was not calibrated correctly. Hence, if the pulse of the heteroatom is not known and perhaps hard to calibrate, it is better to run an HMQC. Another disadvantage of the HSQC is due to the fact that the magnetisation transfer from carbon to proton relies on a reverse INEPT sequence. This works fine, as long as there are no passive couplings interfering that do have about the same size or are even bigger than the active coupling. However, if those couplings do exist, they have to be taken into account, otherwise the signal will be smashed. Therefore in many heteroatom compounds the HMQC works much more reliable than the HSQC.

11.1.1 Pulse sequence and a few NMR details

All predefined parameter sets for different versions of the HSQC contain gradients. Therefore we will also discuss a gradient experiment here. Gradients can be used to improve spectral quality and run spectra in a shorter time, as phase cycling can be reduced or may even become superfluous.

Generally the challenge of an inverse chemical shift correlation experiment is that the large signals from ^1H not coupled directly to a ^{13}C nucleus must be suppressed in a difference experiment, which poses a dynamic range problem. Common techniques for the suppression of ^1H bound to ^{12}C are the BIRD-sequence in HMQC experiments and a trim pulse of 1-2ms during the first INEPT in HSQC experiments. However, the suppression is still imperfect and usually additional phase cycling is required. The introduction of pulsed field gradients in high-resolution NMR greatly improved the problem of suppressing signals from ^1H bonded to ^{12}C : The suppression is almost perfect without additional phase cycling.

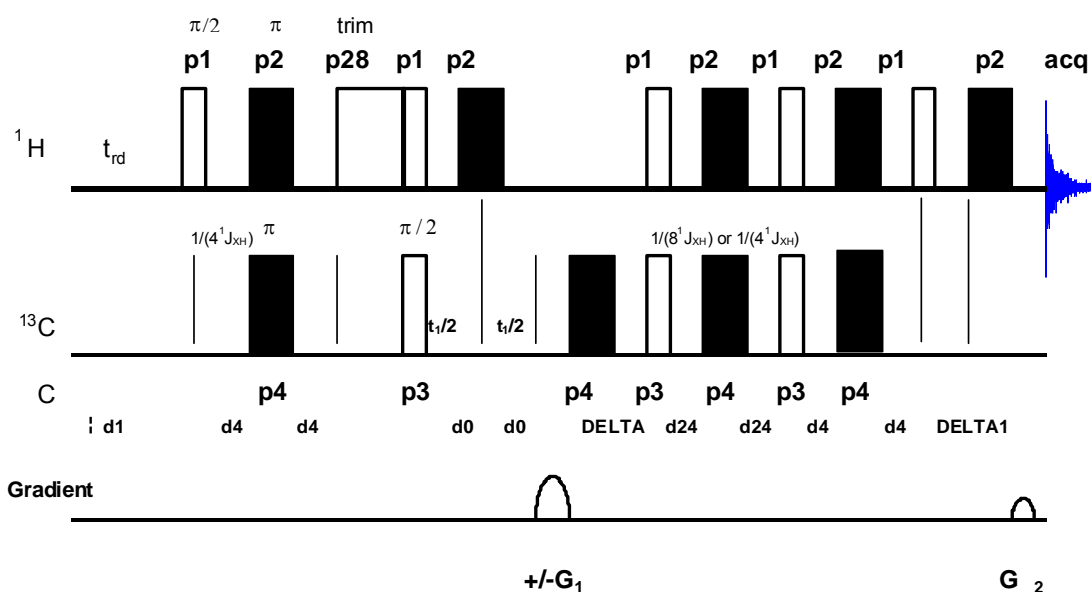
An HSQC yields the same spectrum as an HMQC but is based on single-quantum NMR. In the HSQC sequence, the pulse scheme prior the t_1 evolution period represents a so called INEPT sequence and creates transverse single-quantum magnetization on the X-nucleus, e.g., ^{13}C or ^{15}N , which evolves X chemical shift during t_1 . The G_1 gradient dephases all the

transverse magnetization. This gradient is located in a spin echo in order to refocus chemical shift evolution during the gradient. Then, a second INEPT segment transfers the magnetization to ^1H , where it is detected after it has been rephased by a second gradient G_2 .

The field gradients in this version of an HSQC experiment are solely used for the coherence selection. The gradient ratio $G_1:G_2$ for an HSQC is 4:1 for ^{13}C and 10:1 for ^{15}N .

This version of the HSQC experiment is phase sensitive. The pulse sequence for the HSQC is shown in Figure 11.1.

Figure 11.1: GRASP-HSQC Pulse Sequence



11.2 Preparation and Acquisition


The steps that belong to the spectral acquisition are all arranged in the NMR spectra acquisition guide, which may be invoked from the **Acquisition** → **Data Acquisition Guide** menu.

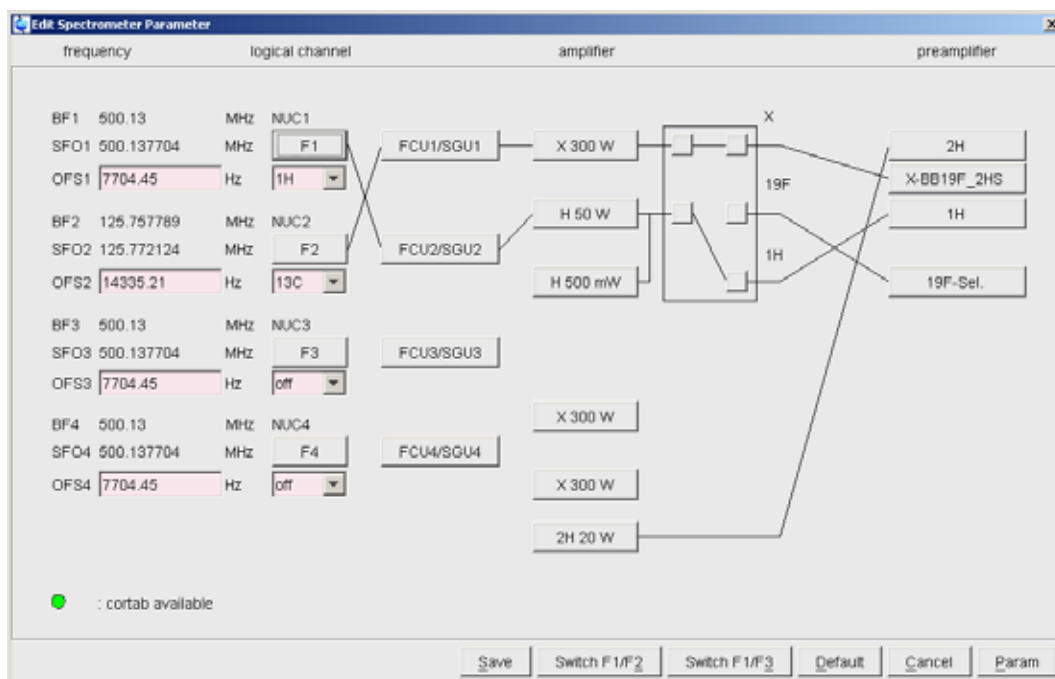
11.2.1 Data acquisition step by step

- Make sure that the sample tube is properly adjusted in the spinner if needed and insert it into the magnet. (For more information on sample preparation and handling, please refer to chapter 1.4).
- If needed, make a new dataset, type **edc** or **new** or select **File** → **New** from the menu.

Here, the dataset name, the experiment number (**EXPNO**), the processing number (**PROCNO**), the directory and the user name are entered. All of these entries will become directories on the respective hard-disk. (For more information on directory structures, refer to chapter 1.3).

You may also choose the correct solvent in the **Solvent** field and select a parameter-set here in the **Experiment** field. The experimental parameters for acquisition, processing, plotting and output will be loaded from the selected parameter-set as if you would have typed **rpar**. You may also give a title.

- Lock the sample by typing **lock** and select the correct solvent.
- Enter **edasp** or click on the button  and select “13C” for the second channel. Press “Save” to return to the main window.



- Match and tune the sample either manually by typing **wobb** and physically adjusting the matching and tuning sliders or screws on the probe for both channels – if you do not have an ATM probe – or automatically by typing **atma** – if you do have an ATM probe.
- Shim the sample either manually or by using the gradient shimming automation routine, type **gradshimau**.
- If you have not selected a parameter set yet (see above), type **rpar PROTON all**. This will select the 1D PROTON standard parameters. (For more information on parameter-sets, refer to chapter 1.3.)
- Type **getprosol** and run a preparatory 1D proton experiment to judge spectra quality and to get a reference for sweep width and transmitter offset (see chapter 2).
- Increase the experiment number in the same experiment set by typing **edc** and changing experiment number and eventually the parameter set to HSQC. You can also type in the command **ixpno** instead. This will just increase the experiment number by 1.
- If you have not selected a parameter set yet (see above), type **rpar HSQC all**, respectively. This will select the HSQC standard parameters, which may be used as they are or which may be adjusted to your needs later. (For more information on parameter-sets, refer to chapter 1.3.)

- Type **getprosol** to load the probe dependent parameters!
- Type in the command **edc2** to define the reference proton spectrum. Enter the correct experiment and processing number in the according field of data set 2. If a 1D carbon spectrum exists, it can be entered as data set 3.

- Adjust acquisition parameters or start the acquisition. We recommend that you use the automation mode by typing **xaua**. You may also start the receiver gain adjustment manually (type **rga**) and then start the acquisition and type **zg**.

11.2.2 Important acquisition parameters for this experiment

There are some acquisition parameters that may be modified for this experiment. The values of the parameters may be edited by clicking the AcquPars tag in the main window. You may access the full set of all acquisition parameters also by typing **eda** or a reduced set, where only parameters are displayed that are relevant for the selected pulse program by typing **ased**. Each parameter may also be accessed by typing its name in lower case letters.

In contrast to the 1D experiments there are 2 columns visible in the acquisition parameter editor. The first column belongs to the direct or F2 dimension, the second one to the indirect or F1 dimension. Note that for inverse heteronuclear experiments, the proton parameters are set in the direct dimension F2, whereas the parameters for the heteroatom are set in the indirect dimension F1.

Table 11.1: Acquisition parameters that may be adjusted from the default parameter-set

F2 Parameters		
Parameter	Explanation	Comments and possible values
PULPROG	pulse program for the acquisition	Use the hsqcetgps2 pulse program which yields a phase sensitive gradient HSQC.
NS	number of scans	The minimum number of scans is 1. You can use any number of scans to yield a better signal

		intensity, however the experiment lasts longer then.
DS	dummy scans	16 dummy scans are appropriate for this experiment.
TD, AQ	time-domain, acquisition time	These 2 values depend on each other. To avoid too much data td in F2 is generally set to 1-2k.
SW	spectral width	sw (in ppm, or correspondingly swh in Hz) defines the width of the proton spectral window and it has to be large enough to incorporate all peaks of the spectrum. Choose the whole range where signals are visible plus one additional ppm to either side. If you run a 1D proton spectrum in advance, define it as a reference with edc2 and start the acquisition with xaua , an automatic sweep range adjustment will be done.
O1P	transmitter offset	o1p (in ppm or o1 in Hz or sfo1 in MHz) defines the center of the proton spectral window (sw or swh). The signals should be centered around this value. If you run a 1D proton spectrum in advance, define it as reference with edc2 and start the acquisition with xaua , an automatic offset adjustment will be done.
D1	recycling delay between two scans	To save time, d1 is set to about $1.25 \cdot T_1$ of the protons. For most molecules, 1.5-2 s is an appropriate value.
D24	delay for multiplicity selection	If d24 is set to $1/8 \cdot J(\text{CH})$ all multiplicities will give rise to a cross peak (this is the default), if it is set to $1/4 \cdot J(\text{CH})$ only XH will show a signal.
CNST2	$^1\text{J}(\text{CH})$ coupling constant	The typical value is 145 Hz for an intermediate one bond CH coupling constant. This value will yield good signals for almost all common molecules. However, it may be a good idea to adjust the value, if the molecule contains for example only aromatic carbon atoms. The program will

		automatically calculate the delay d4 necessary for an effective magnetization transfer from cnst2 .
RG	receiver gain	This is automatically adjusted using the commands xaua or rga .
NUC1	nucleus in F1	For inverse experiments this is ¹ H.
P1, PL1	probe dependant pulse length and high power level	These parameters are dependant on the individual probe and are loaded by the getprosol command. p1 defines the length of the 90° proton pulse at the power level pl1 .
P28	trim pulse	Probe dependant pulse width of the trim pulse that will be automatically loaded by the getprosol command.
GPNAM1 – GPNAM4	Gradient shape	Shape of the gradients used. Set it to SINE.100 .
GPZ1	Gradient strength	This value must be set correctly for the coherence selection. Set it to 80%.
GPZ2	Gradient strength	20.1% for a CH correlation, 8.1% for an NH correlation.
GPZ3	Gradient strength	11%.
GPZ4	Gradient strength	-5%
P16, P19	Gradient pulse length	Probe dependant gradient pulse length. They will be automatically loaded by the getprosol command.

F1 Parameters

Parameter	Explanation	Comments and possible values
TD	number of experiments	This value determines how many points are recorded in the indirect dimension. 256 is an appropriate value.
FnMODE	determines quadrature detection in F1	For phase sensitive spectra gradient spectra choose “Echo-Antiecho”.
ND_010	number of incremented delays	2. There are two incremented delays in the experiment.
SW	sweep width	Choose it large enough to cover the whole chemical shift range of

		the carbon atoms bound directly to a proton. Usually 160 ppm is enough. This value will <u>not</u> be automatically adjusted. Note that signals that are outside the range defined by sw and o2p will fold in the spectrum!
O2P	¹³ C offset	o2p (in ppm or o2 in Hz or sfo2 in MHz) defines the centre of the carbon window (sw or swh). It should be chosen in a way, that the expected signals are centred around this value. 80 ppm is an appropriate value. This value will <u>not</u> be automatically adjusted. Note that signals that are outside the range defined by sw and o2p will fold in the spectrum!
NUC1	nucleus in F1	Set it to 13C.
P3, PL2	probe dependant pulse length and high power level	These parameters are dependant on the individual probe and are loaded by the getprosol command. p3 defines the length of the 90° carbon pulse at the power level pl2 .
CPDPRG2	decoupling pulse sequence	This determines the composite pulse sequence that will be used for carbon decoupling during the acquisition time. A garp sequence is used here.
PCPD2, PL12	Probe dependant decoupling pulse length and power	These parameters are dependant on the individual probe and magnetic field. They are loaded with the getprosol command. pcpd2 defines the length of a low power 90° pulse used by the decoupling sequence while pl12 is the corresponding power.

11.3 Spectral processing

After the spectral acquisition has finished, the data has to be processed. You may do this either automatically using the **xaup** command or manually.

11.3.1 Automatic processing

The command **xaup** will invoke the automation AU program that is stored along with the processing parameters in the **aunmp** parameter. In this case the **aunmp** AU program is called **proc_2dinv**.

Typing **xaup** will automatically process the data and thus it will generate a phase corrected spectrum and it will also perform a baseline correction. By default, a plot will be created using the plot-layout which is also stored in the processing parameters. For the HSQC parameter-set this layout file is called **2D_inv.xwp**.

11.3.2 Manual processing

The acquired data may also be processed manually. The steps that belong to the spectral processing are all arranged in the NMR data processing guide, which may be invoked from the **Processing → Data Processing Guide** menu.

Window function: In 2D experiments the window functions can be used to diminish truncation artefacts, to enhance wanted signals over unwanted (for example diagonal peaks) and to improve the peak shape.


As the number of acquired points in a 2D experiment must be kept rather low for time reasons and to avoid too much data, the recorded FID is heavily truncated. The same issue occurs in the indirect dimension, although here the effect is even bigger, as the number of increments defines the number of points here. To avoid truncation artefacts (wiggles) in the resulting spectrum, sine-functions are used in both dimensions to force the FID to go down to zero.

To set the window functions it is easiest to click on the tag ProcPars and go to the sub menu Window Functions. For the parameter WDW several functions can be chosen from the pull down menu. Use SINE for a normal sine bell function or QSIN for a squared sine bell function, which approaches the zero value at the end of the FID a little smoother, than the pure sine bell.


SSB is a value that determines, by how much the sine function is shifted. If it is set to 0, the maximum is in the beginning of the curve. If it is set to a value n , the sine bell is shifted by π/n . For a phase sensitive HSQC **ssb** should be set to 2 in both dimensions. If there are still some wiggles occurring after the fourier transformation. Try some other values for **ssb** (3 or 4) and see whether this improves the appearance of the spectrum.


Fourier transformation: After the application of the window function, the time domain data has to be Fourier transformed to yield a frequency domain spectrum. This is achieved with the command **xfb**.


Phase correction: After fourier transformation, the spectrum needs to be phased. There is an au-program that takes care of an automatic phase correction. It can be started with the command **calcphinv**. The program calculates the required values for a phase correction in F1 and F2. After this the data needs to be fourier transformed again to apply the calculated phase correction.

It is also possible to manually phase correct the spectrum. Click the phase correction button  or type **ph** and select **manual phasing** from the dialogue


window. The window will now show the spectrum with a cursor cross and some icons on top. Now some rather strong peaks should be selected that are spread as far as possible over the spectral range. To do this move the mouse, until the cursor is over a peak, click the right mouse button and select **Add** from the menu. That way, the rows and columns along the cursor cross will be added to the rows and columns that will be shown when going to the phasing itself.


To adjust the phasing of the rows, click on the  button. The selected rows will be displayed as 1D spectra. The position of the reference- or pivot point is indicated by a red vertical line. By default, the highest peak of the first row is defined as the pivot point. However, this may be a peak which is located in the central part of the spectrum. If this is the case it is advisable to define a peak somewhere close to the edge of one of the rows as pivot point. Move the cursor over the peak, press the right mouse button and select **Set Pivot Point** from the context menu.


Use zero order phase correction to correct the phase around the area of the pivot point: place the cursor over the  button, hold down the left mouse button and move the mouse up or down. Thus, adjust the 0 order phase value until the baseline around the peak at the pivot point is flat and the peak itself is positive.

Then adjust the first order phase value in the same way by holding down the left mouse button over the  button. Move the mouse up and down until a cross peak on the opposite side of the spectral region is phased and the baseline around this peak is flat as well.

Note that it may not be possible to phase all peaks into pure absorption, as they may be dephased as well in the indirect dimension. If this is the case, some peaks will contain a negative part. Therefore it may be more useful to look at the baseline, than just at the peaks phase.


By clicking the save-and-return button () , the phase correction will be applied to the spectrum and the values for zero- and first order phase correction will be stored to the corresponding processing parameters of the F2 dimension: **phc0** and **phc1**. Whenever you type **xfb** these phase correction values will be taken into account, as long as the PH_mod under the ProcPars is set to pk.

Now the spectrum may still be out of phase in the indirect dimension. Press the button  and proceed with the phasing of the columns exactly the same way, as with the rows. The resulting phase correction will then be automatically entered into the parameters **phc0** and **phc1** of the indirect dimension F1.

Leave the phasing by clicking the button .

Calibration and referencing: The chemical shift ppm axis may be calibrated. The **sref** command automatically looks for a peak at around 0ppm (± 0.5 ppm) and assumes that this is the TMS or another internal reference substance. It will then calibrate the axes of the spectrum in a way that this peak is at exactly 0ppm in both dimensions. If **sref** does not find a peak at around 0 ppm, it uses the solvent information for the axis calibration.

This method only works unambiguously if you have added TMS or another internal reference compound to your sample and if no peaks from your compound are in the area around 0ppm.

You may also use the manual mode to calibrate the spectrum. Zoom into a diagonal peak of interest, which you'd like to set to a certain ppm value (e.g. a strong signal whose chemical shift is known). To zoom into a certain region of a spectrum, hold down the left mouse button in the spectrum display and drag the cursor over the area of interest. Then click on this button  to enter the manual calibration mode.

Place the cross of the cursor over the center of the peak that you'd like to use for calibration and click the left mouse button. Enter the desired frequency for both dimensions into the calibration window that opens up. Click **OK** and you're taken back to the default display and the axis calibration is stored into the processing parameters as the **sr** parameter. This parameter is also adjusted by the **sref** command.

Baseline correction: The baseline of the spectrum may be corrected automatically. This has to be done separately for both dimensions. Type **abs2** and then **abs1**. This will perform the correction first in the F2 dimension and then in F1. The commands will apply a polynomial baseline correction where the order of the polynomial function is defined by the processing parameter **absg**. The value of **absg** may range between 0 and 5. The default values of **absg** stored with the HSQCGP parameter sets are 5 for both dimensions.

Automatic baseline correction may also be applied only for parts of the spectrum. The processing parameters **absf1** and **absf2**, which can be found under the ProcPars tag for both dimensions, define the left and the right limit of the spectral region (in ppm), where the baseline correction should be applied. Then use the command **absf1** and **absf2**, respectively to correct only the selected regions.

11.3.3 Processing parameters

The processing parameters may be displayed by selecting the ProcPars tag in the TopSpin display window or by typing **edp**. Some of these processing parameters govern certain processing commands and may be optimized before the application of the respective processing command. Each parameter may also be accessed by typing its name in lower case letters.

Table 11.2: Processing parameters that may be adjusted from the default parameter-set

F2 Parameters		
Parameter	Explanation	Comments and possible values
SI	Size of the real spectrum	This corresponds to TD in the acquisition parameters. si defines the number of real data points that are used for the processing. If the value for si is larger than $\frac{1}{2}$ td , zero filling is applied since td is given in

		complex numbers. Zero filling smoothes spectra, so usually si = td . If si < ½ td , then some of the acquired data points are not taken into account!
SR	Spectral reference	This parameter is altered by the spectral referencing. It is 0 if no axis referencing is performed.
WDW	Type of the window function	This parameter defines, which type of a window function will be applied in the direct dimension. Choose SINE or QSINE
SSB	Shifted sine bell	ssb determines where the maximum of the applied sine bell window function is. Set it to 2 for phase sensitive spectra.
PH_mod	Phase correction mode	This must be set to pk. The phase values of ph0 and ph1 will then automatically be applied in all proceeding fourier transformations.
ABSG	order of the polynomial for abs	$0 \leq \mathbf{absg} \leq 5$. Usually absg = 5 works for most spectra.
BC_mod	Baseline correction on the FID	This value determines the polynomial order of the baseline correction that is performed on the FID. Set it to quad.

F2 Parameters

Parameter	Explanation	Comments and possible values
SI	Size of the real spectrum	If the value for si is larger than ½ td , zero filling is applied on phase sensitive spectra since td is given in complex numbers. Zero filling smoothes spectra, so usually si = td . If si < ½ td , then some of the acquired data points are not taken into account!
SF	Spectral reference	This parameter is altered by the spectral referencing. It is 0 if no axis referencing is performed.
WDW	Type of the window function	This parameter defines, which type of a window function will be applied in the direct dimension. Choose SINE or QSINE

SSB	Shifted sine bell	ssb determines where the maximum of the applied sine bell window function is. Set it to 2 for phase sensitive spectra.
PH_mod	Phase correction mode	This must be set to pk. The phase values of ph0 and ph1 will then automatically be applied in all proceeding fourier transformations.
MC2	Type of fourier transformation	The value of mc2 depends on the FnMODE that was chosen during acquisition. Set it to Echo-Antiecho.

11.4 Post-processing

After the spectra are processed (Fourier transformed, referenced and baseline corrected), peaks may be picked and the spectrum may be plotted for further interpretation.

11.4.1 Peak picking

There are different options on how to perform peak picking.

In order to display the picked peaks, right click in the spectrum display window and select “display properties” from the context menu and tick the box “Peak labels”.

The picked peaks are stored in a peak list text file which may be displayed by selecting the “Peaks” tag in the main window. The peak list is interactive and you may correlate it with the spectrum and display spectrum and peak list at the same time. Right click in the peak list table and select “show spectrum” → “in correlated window” from the context menu. If you now move the mouse cursor over any entry in the list, the cursor in the spectrum will automatically jump to the corresponding peak in the spectrum. The peak list may also be exported as a text file or peak list file. Right click in the peak list window and select the “export” option from the context menu.

Automatic peak picking on the displayed region: To start the peak picking dialog window, type in the command **pp**.

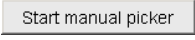


You have the option to append the data to a presumably already existing list. If this is not checked, the procedure will create a completely new peak list. If it is checked it may be wise to skip already existing peaks within that list, this means: not entering it a second time to the existing peaks.

The parameters that can be set include the region. Click on the “Set to” button. Here you can choose, whether you want to peak pick the complete processed spectral range, only the displayed region, the region that is defined by the F1/F2 parameters (which can be adjusted with the command **f1p** and **f2p**, respectively) or the region that was chosen during the last peak picking routine. Of course you can also type in the desired values directly in the peak picking dialog window. Note that the whole region can also be peak

picked without opening the graphical interface with the command **ppf**, whereas only the region defined by **f1p** and **f2p** is used when the command **pps** was applied.

The sensitivity can be altered in several ways. First a lower limit for the smallest intensity that should be recognized as a peak can be entered. You can type in any value for MI or go to the “Set to” button and choose either the lowest contour level, the MI value already stored with the dataset or the MI value used during the last peak picking routine. If the value is too low, too many peaks will be picked, if it is set to a too high value, weak peaks will be missed. A similar limitation can be applied to the maximum intensity. If MAXI is set to a smaller value than 1, every peak that has a higher intensity will not be picked. The diagonal gap allows to define a certain number of points around the diagonal, that will not be considered during peak picking. That way the diagonal peaks of homonuclear spectra will not be entered in the peak list. The smaller the resolution value is, the closer 2 peaks may be to be still considered as 2 separate peaks.

For an HSQC only positive peaks need to be detected.

Manual peak picking: The manual peak picking mode can be started either from the peak picking dialog box by pressing the button  or directly from the main TopSpin window by clicking on the icon . You will enter the peak picking window. Set the cursor over a peak, click with the right mouse button and confirm, that the peak should be added to the peak list. To delete a peak, right click on an already marked peak and click on “Delete Peak From List”. If you click on “Annotate Peak” it is possible to add any desired assignment to the peak. Leave the dialog with the  button.

11.4.2 Projections

It is possible to show 1D spectra on either side of the 2D plot. This may be helpful, to identify cross peaks within spectrum. To toggle the display of the projections on, right click on the 2D spectrum and select the “Display Properties...”. In the dialog window toggle on the option “Show projections”. On the bottom it is possible to choose, whether the projections in F1, in F2 or in both dimensions should be visible. The moment, the projection display is turned on the positive projections are displayed above the spectrum and to the left as a default.

Display of a recorded 1D proton or carbon spectrum: Right click with the mouse over the displayed projection and choose the option “External projection”. A dialog box will open where you can type in the path information of the dataset that should be displayed.

Alternatively it is possible to start a projection display dialog box with the command **projd**. On top the option “Display 1D spectra along with the 2D spectrum” should be toggled on. If the checkbox is ticked it is possible to enter any 1D dataset for the F2 (left) and the F1 (right) dimension, respectively. After clicking **OK** the spectra will be displayed.

Display of internal projections: To switch back to the internal projections, right click over the projections and choose the option “Internal Projection”. The positive internal projection will be displayed again.

Alternatively it is again possible to use the command **projd** and toggle on the option “Display projections along with the 2D spectrum” on the top. After clicking **OK** the internal positive projections will be displayed.

11.5 Spectra interpretation

.Constitution and molecular structure: In an HSQC cross peaks are showing a one bond coupling in between a proton and a carbon spectrum. Hence it is possible to find out, which protons are directly bonded to which carbon. It is also a rather quick method to record a carbon spectrum, as the sensitivity is higher than in a 1D carbon experiment and the relaxation delay can be chosen a little shorter. Note however, that quaternary carbon atoms will give no signal in an HSQC!

11.6 Possible pitfalls

Using the standard parameter set, which is called up by typing **rpar HSQCGP all** and **getprosol** (see the chapter on data acquisition), will lead to satisfactory spectra without the need to change parameters.

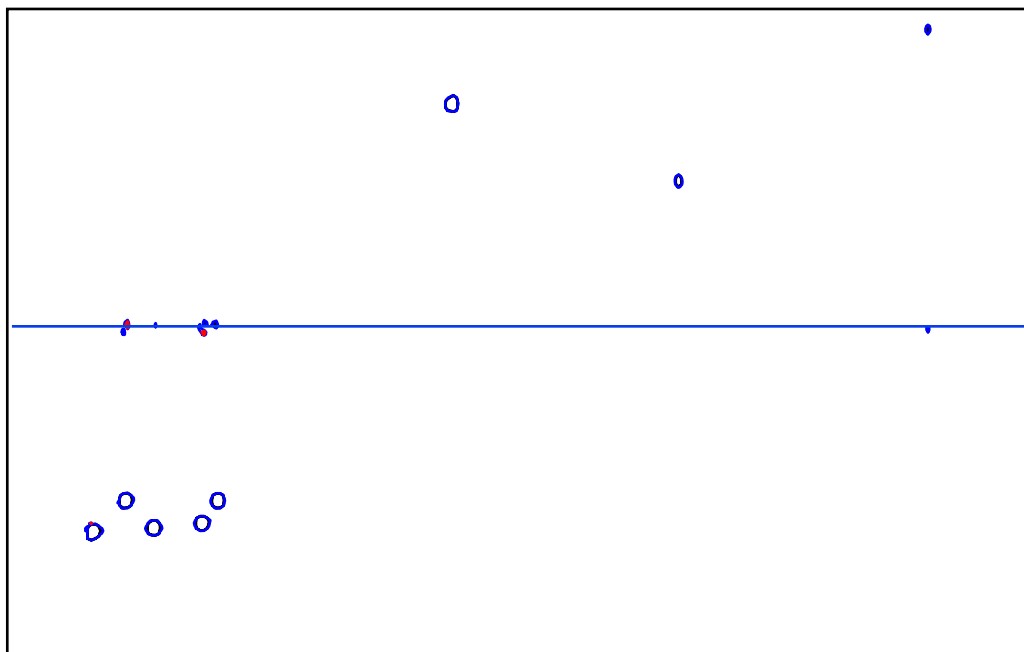
Some basic issues (lineshape, sample concentration and shim) should be checked already in the preparatory 1D proton experiment (see chapter 2)

However some common pitfalls and artifacts that may lead to unsatisfactory results are described here. We describe the most commonly observed phenomena and the causes as well as solutions to these relatively common things.

- For 2D experiments, spinning should always be turned off, as the spinning may introduce artefacts leading to criss cross noise in the spectra (see Figure 7.4). Note that you have to adjust the z and eventually also the z^2 shim, if you stop sample rotation. Therefore it is best to run already the preparatory 1D experiment without spinning.
- The number of scans and dummy scans needs to be a multiple of the minimum given in the pulse program. If that is not the case, the phase cycle is not completed which may lead to auxiliary diagonals parallel to the real diagonal (see Figure 6.4).
- Miscalibration of chemical shifts by up to 0.5ppm: This happens sometimes in the automation – either in IconNMR or using the **xaup** command – if no internal standard has been added. The reason is that the **sref** command finds a very small peak (possibly noise) close to 0ppm. It assumes that this is TMS and sets it to 0ppm. You may undo this by setting **sr** to 0Hz.

- If the recycle delay $d1+aq$ was chosen too short, rapid scanning artifacts will show up in the spectrum. In an HSQC they will appear as axial peaks (Figure 11.2). To avoid them increase the relaxation delay $d1$.

Figure 11.2: Axial peaks in an HSQC resulting from a too short relaxation delay $d1$.



12 Plotting

12.1 Starting the program

The program is usually started directly from TopSpin, by typing the command **plot** on the command line. This will open a new window, where the spectrum is displayed with a layout that is defined under the Automation menu of the ProcPars of the dataset the program was started from. This layout file is usually a standard Bruker file that defines which objects (1- or 2D spectra, parameters, title, logos, etc.) will be displayed on the plot, as well as their size and exact position.



Starting the plot editor with **plot** means that the ppm-scale and y-scaling will be taken directly from the TopSpin view. So you can zoom into the desired region in TopSpin already before starting the Plot Editor. The **plot** command will then first store the actual spectral limits in F1/F2 and then switch to the Editor. However, you can also start the program with **plot -r**, which will include a reset action on the actual spectrum. This will lead to an automatic adjustment of the axes and y-scaling according to the region defined in F1/F2 for the actual spectrum as well as the intensity of the signals. These are parameters stored with the dataset. Another option is **plot -n** which uses the scaling information of the layout. This can be useful, if you want to plot several spectra with exactly the same regions and scaling.

Once the program is started, changes and adjustments can be made via the menu, the icon buttons and the mouse. Many features are implemented in a way, you will know from many drawing programs available on the market, so that the usage is quite intuitive for people who had been working with such programs before. Generally a printout will look exactly the same way, as the picture visible on the screen (What you see is what you get). However it is still possible to adjust everything precisely to a certain scale or position, if that is wanted.

As mentioned before, the layout file only stores information about the size and position of the objects. So you are not storing the complete printout. To reprint the same spectrum the same way once again, you would have to use the same layout file and read in the dataset. This can be done either by starting the plot editor directly from the wanted dataset or you can work with portfolios – these are simply a bunch of spectra that can be used and read in directly from the Editor without going back to TopSpin. It can also be used, if you want to print more than one spectrum on a plot.


If you have the necessity to plot a spectrum without any user interference, this is possible by using the command **autoplot**. If you type this the program will plot the actual dataset with the layout file stored under ProcPars. This command is also used in some au programs that are responsible for the processing and plotting during automation.

12.2 Plotting a 1D spectrum

After acquiring and processing a 1D spectrum zoom into the region you want to print and start the Plot Editor with the command **plot**. A new window will open, with the actual spectrum showing exactly the same region as in TopSpin. If you like it the way it is, you can directly press the print button  or the multiple print button  if you need more than one printout.




12.2.1 Basic editing of a 1D spectrum

If you don't like the appearance of the plot, you can edit it in several ways.



To change anything about the plot objects you have to select them by first clicking the  button and then the object you want to change. The moment an object is selected, all following editing tasks will only affect this one object.


To get rid of an unwanted object click on  in the object tools bar.

Resizing can be achieved by left clicking on the border of the selected object and keeping the mouse button pressed while moving it.

To change color and appearance click on . A window will pop up, where you can choose an appropriate color, line width and style and font type and size. Choose something and click on  to adapt the attributes to the object and stay in the menu or directly on  to confirm the changes and leave the attributes window.

With the  button you can always revoke the last command.

The  button allows you to edit some basic features of the object. For every object there are the 2 submenus called "Data Set" and "Basic". Under "Data Set" you can choose a different NMR-dataset. As the information for NMR objects is stored within the dataset, this means for example, that you can choose to display a spectrum, title or parameters of a different measurement. If you click on the  button you will come to the portfolio editor. All datasets included in the actual plot (projections, 1D- and 2D spectra) can be selected by clicking on them and pressing "Apply". If other datasets are needed, go to "Edit", select the missing dataset from the browser, click on "Append" to add the dataset to the portfolio and leave the browser with "Apply". The new dataset will then be available in the portfolio.

The "Basic" parameters contain the exact position and size of each object. If an interactive size adjustment is not precise enough for your needs, you can tell the program exactly, where the object should start and how wide and high it should be in total. The  button brings you back to the color, line and font window like the same button in the object tool bar on top of the layout window.

The other submenus of the editing window are object dependant. If the object contains text, there is a "Text" menu, where you can change the alignment and allow some options. Furthermore you can edit the text itself or load a text from a data file which can then be loaded.

Interesting to most users are only the 2 submenus showing up when editing a spectrum. Here you will find a "1D Spectrum" menu where you can define whether the axes shall be labeled in ppm, Hz or points, whether you want the

peak marks and labels to be displayed or not and whether you want the integrals to be shown and how many digits the integral labels should have. Furthermore, a scaling information for the x axis is available.

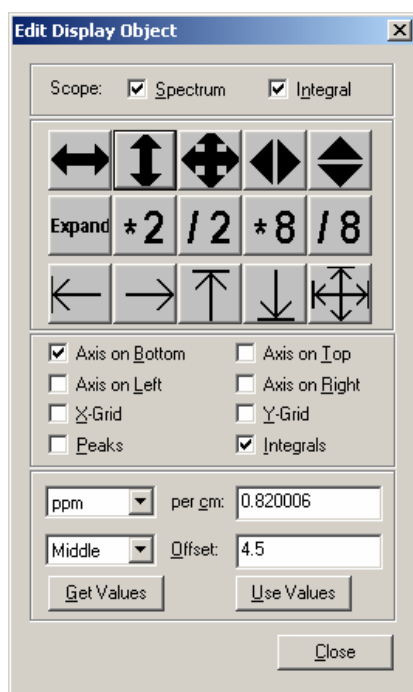
The “Graph” menu allows you to define precisely how much of your spectrum shall be displayed in terms of ppm or Hz. Besides that you can choose where the axes and grids shall be displayed. For all (axes, grids, integrals, spectral curve) you can choose separate attributes by clicking on the button in the appropriate field.


Only in cases, where you selected an NMR object containing a spectrum or FID the **1D/2D-Edit** button will be active. If you click on it, a window will open where you will find the scaling tools known from TopSpin on top (Figure 12.1). With these you can easily shift, expand or rescale your spectrum to the measured region. For shifting and interactively expanding the spectrum, you have to keep the left mouse button pressed while moving it. The other buttons will just resize the spectrum by left clicking the button once. Depending on, whether the checkbox “Spectrum” or “Integral” is checked these actions will affect only the spectrum or integral, respectively. If both are checked, spectrum and integral are changed.

Below the scaling tools there are a few checkboxes, where objects can be turned on or off. You can choose here, whether you want to display an axis, a grid, integrals and peaks. Please note, that checking the “Integrals” and “Peaks” boxes will result in integrals and peaks respectively and their labels to be shown. To display only part of it, you have to go to the **Edit** menu.




On the bottom you can choose, how many ppm or Hz should be shown per cm on the x-axis. Furthermore you can define an exact ppm-value, you would like to have to the left, right or in the center of the spectrum.


Figure 12.1: 1D editing box.




After applying all necessary changes you can save the new layout by clicking the  button and giving it a new name. Note that this will only save the layout! The dataset needs to be read in separately. However, this allows you to use exactly the same layout for several different datasets.

12.2.2 Inserting an expansion




The predefined dataset 1H+zoom.xwp already contains an expansion additionally to the normal 1D spectrum. Enter this layout in the processing parameters and start the Plot Editor with **plot**. Two spectra will be generated on the same plot with the same width and spectral region displayed. You can now interactively zoom into the desired region of the upper spectrum using the expand button, . Left click on it and then click inside the spectral window on the point where you want to start zooming and keep the mouse button pressed while moving it. The release point will define the end point of the zoom region. Of course you can as well select the spectrum with the  button and zoom in with the scaling tools of the  menu.

If the 1D spectrum already looks the way you want, you may not like the idea of changing to a different layout. In such a case, it may be easier to introduce an extra 1D spectrum. Toggle on the NMR objects on the main switches to the left and click the button . Then click on the starting point of the spectral window and keep the mouse button pressed while moving it. The release point will define the end point of the zoom region. The spectrum in the new window will look exactly like the other one. However, again you may zoom into the desired region using the expand button or the editing menu.



After creating the zoom layout, it can be saved and reused for other datasets. If you want to use exactly the same scaling for a different spectrum, start the Plot Editor from that dataset with the command **plot -n**. That way, the spectral regions defined in the layout are used, not the regions defined in the dataset.

To reuse the layout without leaving the Plot Editor, select all NMR data related windows by clicking the  button and selecting the items with the left mouse cursor while keeping the shift key pressed for multiple selection.

12.3 Plotting of a 2D spectrum


Before entering the Plot Editor it is a good idea to define eventually wanted projections on the x- and y-axis already in TopSpin. To do so click with the right mouse button inside the spectrum and chose . Check the option "Show projections" and choose on the bottom which projections you would like to have. Leave the window with . Now there are automatically the internal projections of the 2D spectrum displayed. To displace them by real 1D spectra, right click with the mouse over the projection and choose "external projection" from the menu. Choose the wanted 1D spectrum and click . The spectrum will be displayed in TopSpin. If you do this the projection spectra will already be included in the portfolio and the projections will be automatically displayed the moment you enter the Plot Editor.

Otherwise they would need to be entered in the Portfolio Editor manually and defined later as the projection spectra.

Now the Plot Editor can be started with the command **plot**. A new window will open, with the actual spectrum showing exactly the same region as in TopSpin. If you like it the way it is, you can directly press the print button  or the multiple print button  if you need more than one printout.




12.3.1 Basic editing of a 2D spectrum

If you don't like the appearance of the plot, you can edit it in several ways.



To change anything about the plot objects you have to select them by first clicking the  button and then the object you want to change. The moment an object is selected, all following editing tasks will only affect this one object.


To get rid of an unwanted object click on  in the object tools bar.

Resizing can be achieved by left clicking on the border of the selected object and keeping the mouse button pressed while you move it.

To change color and appearance click on . A window will pop up, where you can choose an appropriate color, line width and style and font type and size. Choose something and click on  to adapt the attributes to the object and stay in the menu or directly on  to confirm the changes and leave the attributes window.


With the  button you can always revoke the last command.

The  button allows you to edit some basic features of the object. For every object there are the 2 submenus called "Data Set" and "Basic". Under "Data Set" you can choose a different NMR-dataset. As the information for NMR objects is stored within the dataset, this means for example, that you can choose to display a spectrum, title or parameters of a different measurement. If you click on the  button you will come to the portfolio editor. All datasets included in the actual plot (projections, 1D- and 2D spectra) can be selected by clicking on them and pressing "Apply". If other datasets are needed, go to "Edit", select the missing dataset from the browser, click on "Append" to add the dataset to the portfolio and leave the browser with "Apply". The new dataset will then be available in the portfolio.


The "Basic" parameters contain the exact position and size of each object. If an interactive size adjustment is not precise enough for your needs, you can tell the program exactly, where the object should start and how wide and high it should be in total. The  button brings you back to the color, line and font window like the same button in the object tool bar on top of the layout window.


The other submenus of the editing window are object dependant. If the object contains text, there is a "Text" menu, where you can change the alignment and allow some options. Furthermore you can edit the text itself or load a text from a data file which can then be loaded.

Interesting to most users are only the 3 submenus showing up when editing a spectrum. Here you will find a "2D Spectrum" menu where you can define whether the axes shall be labeled in ppm, Hz or points. Furthermore the

attributes for the positive and negative levels can be defined. Note, that here you can only give a unique color to all positive and/or all negative levels. To create a color flow, go to the menu  (see below).

The “Graph” menu allows you to define precisely how much of your spectrum shall be displayed in terms of ppm or Hz. Besides that you can choose where the axes and grids shall be displayed. For all (axes, grids, integrals, spectral curve) you can choose separate attributes by clicking on the button in the appropriate field.

The “2D Projections” menu allows you to determine the size and position of the projections as well as their color and line width. If you press one of the  buttons, you may choose one of the 1D spectra of the portfolio file as a projection. Note that all projections have the same attributes.

If you select the 2D spectrum the  button will be active. Clicking on it will open a window where you will find the scaling tools known from TopSpin on top. With these you can easily shift, expand or rescale your spectrum to the measured region. For shifting and interactively expanding the spectrum, you have to keep the left mouse button pressed while moving it. The other buttons will just resize the spectrum by left clicking the button once.

Below the scaling tools there are a few checkboxes, where axes and grids can be turned on and off.

The scaling tools in the middle of the window will affect the projections that are selected in the toggle menu. So it is possible to position and resize every projection independently of each other.






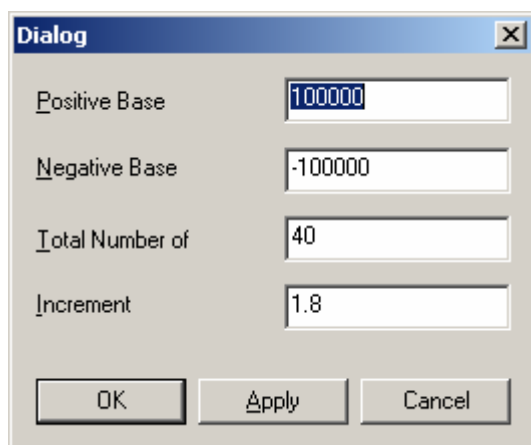



The levels displayed in the PlotEditor correspond to the number of contours defined in TopSpin whereas their color is taken from the layout file. To create the desired number of contour levels it is easiest to first adjust the correct level height with the  button. The number of positive and/or negative levels together with the absolute values of these levels will be displayed in the lower left corner of the window. Now you can add or remove individual levels by typing in the value and clicking on  or selecting the unwanted level and clicking , respectively. However it may be more convenient, to use the level editing dialog which is started by clicking . In the dialog window (Figure 12.2) you can now enter about the same value for the base levels as you find in the levels list – if they were previously adjusted and have a suitable value. If one of the base level fields is left empty, the accordant contours will be preserved. The maximum number of contour levels for each range (positive and negative) is 17. However you have to give in 20 to get 10 positive and 10 negative levels. The increment defines the distance in between 2 contour levels. Usually a value in between 1.2 and 1.8 works out fine. Click on , to see whether you are pleased with the settings.

Figure 12.2: Dialog window for the edition of the contour levels.



To change the color of the contour levels, select the desired levels with the left mouse cursor and choose a color from the color palette. Click on  to set the color. You can select a whole sequence of levels by choosing the first one and then keeping the shift button pressed while selecting the second one. To get a better impression of the relative peak intensity it might be useful to vary the colors of adjacent contour levels slightly. This can easily be achieved by coloring the two outermost levels in a different color and then selecting only these two levels and pressing the  button. The selection of two or more different non adjacent levels can be done by keeping the ctrl key pressed, while selecting additional levels with the left mouse button.

After applying all necessary changes you can save the new layout by clicking the  button and giving it a new name. Note that this will only save the layout! The dataset needs to be read in separately. However, this allows you to use exactly the same layout for several different datasets.